

CONTEMPORARY LOUDSPEAKER SOLUTIONS
FOR MULTIPLE APPLICATIONS



VEGAS



Outline



Welcome to VEGAS, a new series of outstanding modern loudspeakers designed for the contemporary installation and sound reinforcement vertical markets. This new series from Outline offers a complete range of high quality solutions for a large number of applications. It offers versatility, as well as great audio quality, for contractors, installers, integrators and selected sound production professionals. All models feature high quality Italian-made components and are designed, sourced and manufactured to the same stringent quality standards Outline applies to all of their high-end touring audio products. Common characteristics are high intelligibility scale ratings, extraordinary audio fidelity, attractive price points and excellent power-to-size ratios.

Coaxial solutions like **Vegas 8CX, Vegas 12CX and Vegas 15CX** are multi-purpose, full range, 2-way bass reflex enclosures equipped with modern premium custom coaxial drivers and specially designed HF horns. Vegas 8CX and Vegas 15CX incorporate specific rotatable moulded horns which provide Low-Pass acoustical loading on the woofers, increased efficiency in their usable bandwidth, and assist the rejection of out-of-band energy. Coaxial component positioning within the cabinet is designed to minimize negative diffraction and reflections. Carefully chosen materials improve the thermal dissipation properties of the coaxial component, ensuring high performance in terms of power compression, distortion and reliability. A major advantage of coaxial technology is the consistency in off axis response. This can be seen in both the lateral and vertical planes, resulting in improved coherence.

Outline has created unique crossover filters specifically designed to maximize the characteristics of the coaxial component for excellent consistency in frequency, time (impulse) and space (acoustic coverage). The airflow input and output in the ducts are specifically shaped to create a smooth and soft transition for the air, in order to avoid the unpleasant turbulence effect. This results in an enhancement in terms of bandwidth (low end), distortion and maximum SPL.



VEGAS SERIES

Full range two-way solutions like **Vegas 6.5, Vegas 10, Vegas 12, Vegas 15** are equipped with a low frequency woofer, and fitted with a compression driver and passive crossover manufactured with top grade components. This includes coils with very low resistance and metallized polypropylene capacitors. With these tuned enclosures, the low frequency loading is phase inverted. The high quality crossover removes the requirement for external controllers, giving a pre-box impedance of 8 ohms. This makes them very efficient in terms of required amplifier channels. Vegas 10, Vegas 12 and Vegas 15 feature the same compression driver mounted on a rotatable waveguide (90° x 60°) offering greater flexibility. The waveguide can be rotated through 90° to ensure the required dispersion is achieved, no matter what position the cabinet is installed in (horizontal or vertical). The mouth's ample dimensions ensure remarkable directivity control. The shape of the cabinets enables them to also be used as stage monitors.

The ultra compact (280 x 148 x 120mm) **Vegas 24** is a high power, wide-dispersion, externally powered loudspeaker, specifically designed for under balcony fill, front fill and delay applications. A waveguide-loaded design provides and enhances the precedence required for localization, as well as other psychoacoustic effects often specified for quality installations. This allows maximum power within limited installation space.

Vegas are a family of high efficiency solutions for permanent high quality installations. This makes them suitable for clubs, lounge bars, pubs, music-cafés, theatres, conference rooms, stores, shopping centres, malls, rail-way stations, houses of worship and airports.

The flexibility and common-voicing of the Vegas range makes it a very attractive "toolbox" for contractors and installers/specifiers. All Vegas enclosures are made with high quality phenolic-glued Baltic birch wood, and are protected by an epoxy powder coated, resonance-free steel grill over acoustically transparent foam. Every cabinet is coated with a high-tech black textured polyurea scratch-free finish. Custom RAL colour repainting is available upon request. For further extension of the bottom end, and therefore greater dynamics, a line of high performance subwoofers is also available.

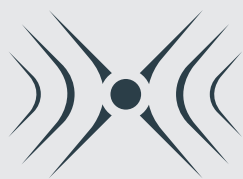

VEGAS_{CX}

FEATURES

- › Compact loudspeakers designed for mobile and fixed installation applications
- › Extraordinary audio fidelity and power handling
- › Premium grade coaxial drivers
- › Predictable and accurate HF directivity control
- › High SPL relative to size and weight
- › Conical dispersion
- › High quality passive network with large inductors and capacitors
- › Asymmetric cabinet design allows for use as stage monitor
- › Pass-through NL4 allows multiple device parallel connection capability
- › All Baltic birch wood dovetail joinery construction
- › Cabinet internally braced to ensure maximum rigidity
- › Designed to prevent internal resonance
- › Fitted with M6 and M8 installation points
- › Black textured polyurea scratch free finish
- › Custom RAL color repainting options
- › Vertical and horizontal mounting hardware options
- › Compatible with Outline Openarray 3D acoustic simulation software
- › Designed, sourced and manufactured exclusively in Italy

DESCRIPTION

The VEGAS 8 CX, 12 CX and 15 CX are designed and manufactured with the same stringent quality standards applied to Outline's world class touring audio products. Contemporary design and efficient manufacturing processes allow Outline to deliver these products with first-class power handling and audio fidelity at a very attractive price point. The three VEGAS CX models are ideal multi-purpose, full-range, 2-way bass reflex enclosures equipped with a modern premium custom coaxial driver. They require only one amplifier channel for correct operation, the frequency splitting between the LF driver and the HF driver being accomplished by the passive crossover network built into the enclosure. The low-loss passive filter ensures a seamless transition between the LF and HF drivers. Combined with the asymmetric cabinet design each VEGAS CX model can be used as a floor monitor or stage front fill if required. Outline's high quality coaxial driver gives excellent sonic performance, increased timbre quality and high power handling characteristics. Cutting edge molding technology has enabled Outline to manufacture horns that are rigid and lighter, resulting in improved distortion specifications and lower overall weight. The high quality internal crossover network is manufactured with top grade components, including coils with very low resistance and metalized polypropylene capacitors. It also features ingenious circuitry to protect the component against excessive current and voltage. Each VEGAS CX delivers high levels of undistorted audio; 8 CX produces a peak of 127 dB, 12 CX 133 dB and 15 CX 136 dB SPL at 1 meter.

The Outline iP24 DSP unit and all Outline amplifiers are recommended for best results. The all-wood 15mm phenolic-glued Baltic birch enclosure features craftsmanship dovetail joinery construction protected by an epoxy powder coated, resonance-free steel grill over acoustically transparent foam. Every cabinet is coated with a high-tech black textured polyurea scratch free finish and custom RAL color repainting options are available for installations with specific cosmetic requirements.

FACILITIES

| | | |
|------------------|------------------------|-------------------|
| Theatres | Clubs/Lounges | Railway stations |
| Auditoriums | Bars/Pubs | Airports |
| Conference rooms | Shopping Centers/Malls | Sports Facilities |
| Churches | Music groups | Theme Parks |
| Cafes | Schools | Broadcast TV |

For further extension of the bottom end and therefore greater dynamics a line of high performance subwoofers is available.

APPLICATIONS

Main PA
 Side Fills
 Drum Monitors
 Floor Monitors
 Delay & Fill
 Foreground Music Systems
 Background Music Systems
 Paging Systems

VEGAS 8cx

COAXIAL LOUDSPEAKER

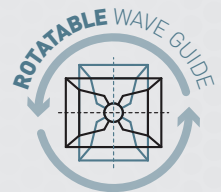

8cx

PERFORMANCE SPECIFICATIONS

| | |
|------------------------------------|-------------------|
| Frequency Response -10 dB | 65 Hz – 22 kHz |
| Nominal Dispersion | 90° x 80° (H x V) |
| Impedance (Nom/Min) | 8 Ω / 7.2 Ω |
| Watts AES (Continuous/Peak) | 250 W / 1000 W |
| Maximum SPL Output * | 127 dB SPL |

* calculated using +10 dB Crest Factor signal @ 1 m, Free Field

PHYSICAL

| | |
|----------------------------|-----------------------------------|
| Component Low | 8" woofer |
| Component High | 1.5" diaphragm compression driver |
| Loading Low | Bass-reflex |
| Loading High | Coaxial rotatable moulded horn |
| Connectors | 2 x NL4 PAR Pins 1+/1-, 4PIN PHX |
| Cabinet Material | Baltic birch plywood |
| Cabinet Finish | Black polyurea coating |
| Grill | Epoxy powder coated |
| Installation Points | 4 x M6, 1 x M8 threaded points |
| Pole Mount | 35 mm socket |
| Height | 420 mm – 16 17/32" |
| Width | 260 mm – 10 1/4" |
| Depth | 270 mm – 10 5/8" |
| Weight | 9.2 kg – 20.3 lb |

DIMENSIONS

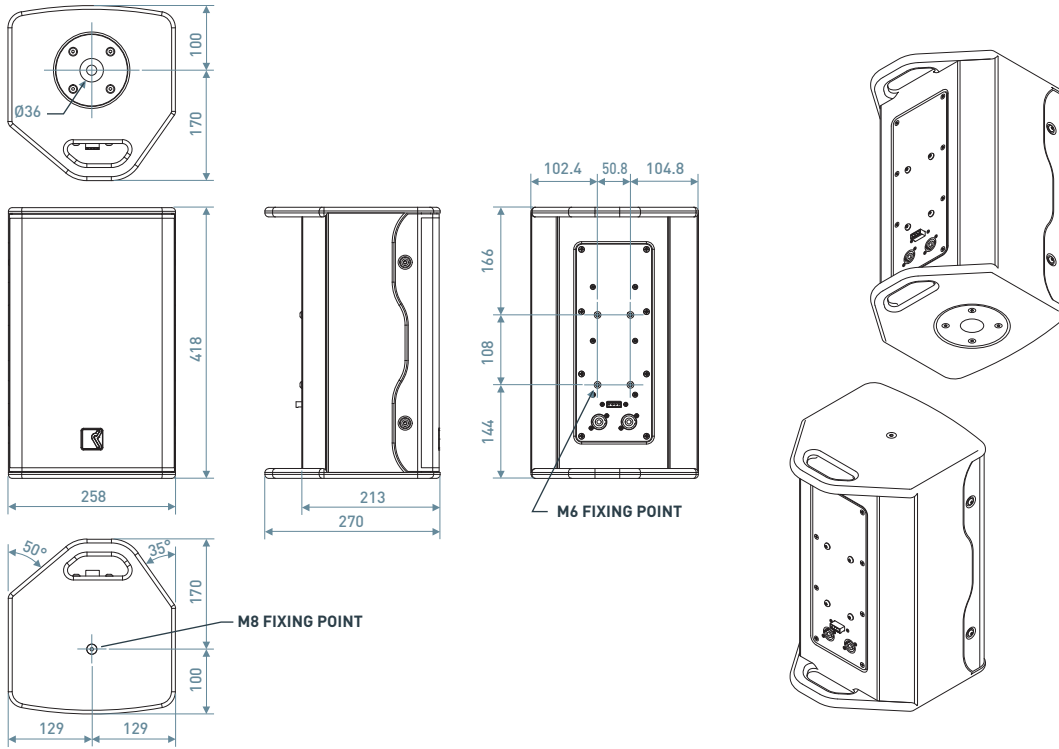

BEAMWIDTH

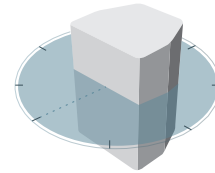
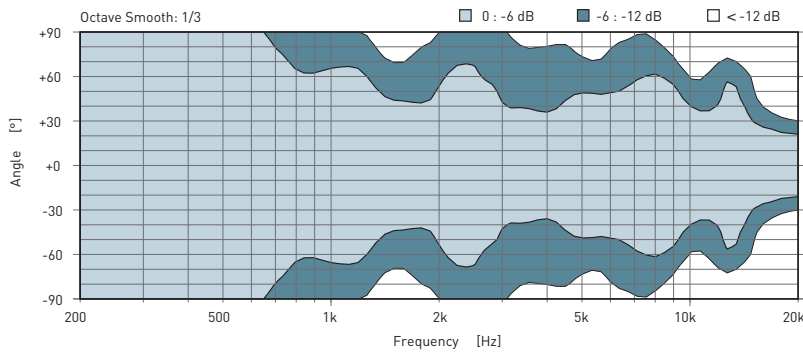

HORIZONTAL

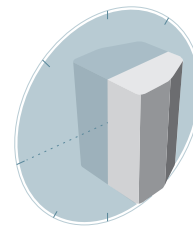
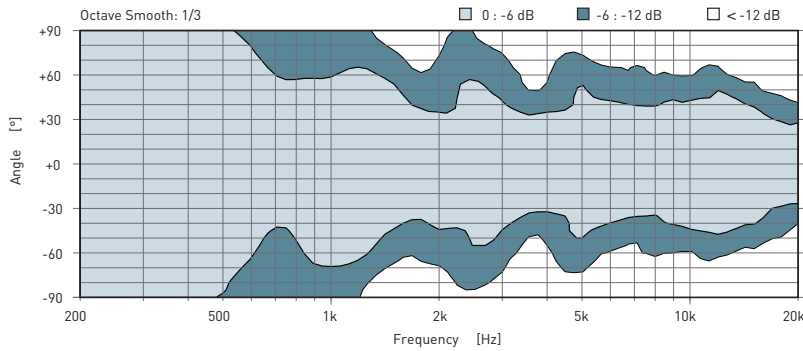

VERTICAL



VEGAS^{12cx}

COAXIAL LOUDSPEAKER



12cx

PERFORMANCE SPECIFICATIONS

| | |
|------------------------------------|-------------------|
| Frequency Response -10 dB | 55 Hz – 20 kHz |
| Nominal Dispersion | 90° x 90° (H x V) |
| Impedance (Nom/Min) | 8 Ω / 6.5 Ω |
| Watts AES (Continuous/Peak) | 450 W / 1800 W |
| Maximum SPL Output * | 133 dB SPL |

** calculated using +10 dB Crest Factor signal @ 1 m, Free Field*

PHYSICAL

| | |
|----------------------------|---------------------------------|
| Component Low | 12" woofer |
| Component High | 3" diaphragm compression driver |
| Loading Low | Bass-reflex |
| Loading High | Coaxial horn |
| Connectors | 2 x NL4 in parallel Pins 1+/1- |
| Cabinet Material | Baltic birch plywood |
| Cabinet Finish | Black polyurea coating |
| Grill | Epoxy powder coated |
| Installation Points | 4 x M6, 16 x M8 threaded points |
| Pole Mount | 35 mm socket |
| Height | 550 mm – 21 21/32" |
| Width | 380 mm – 14 31/32" |
| Depth | 350 mm – 13 25/32" |
| Weight | 19.2 kg – 42.3 lb |

DIMENSIONS

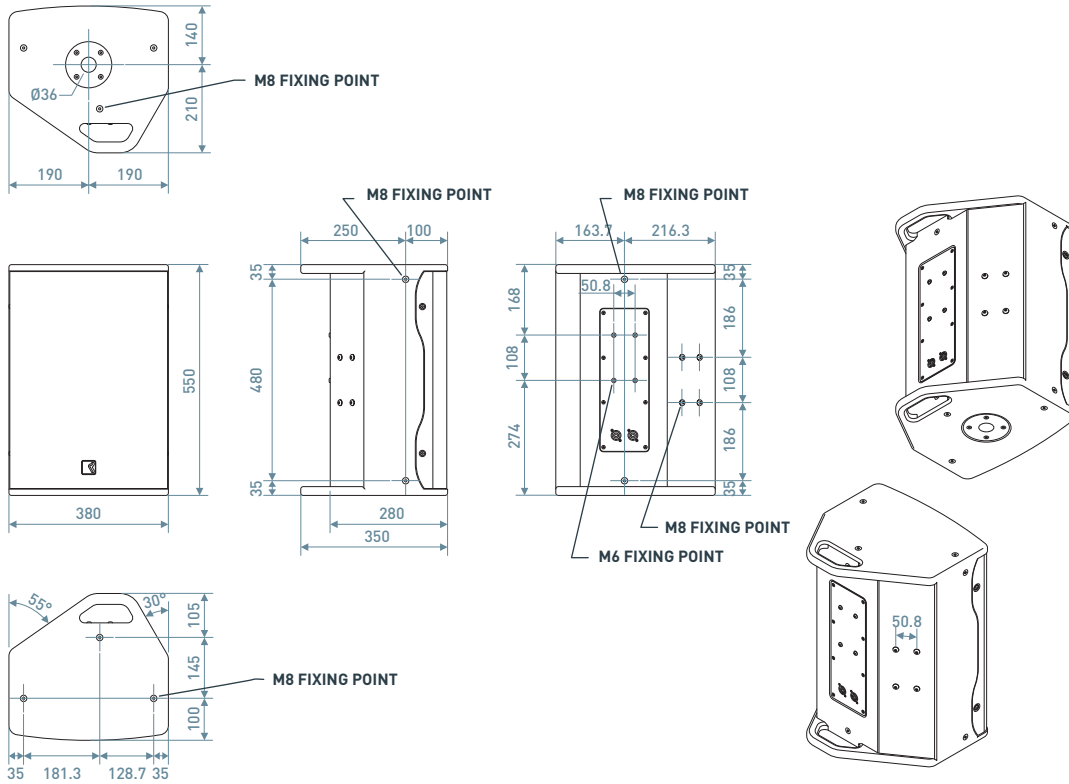

BEAMWIDTH

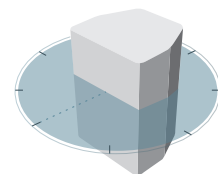
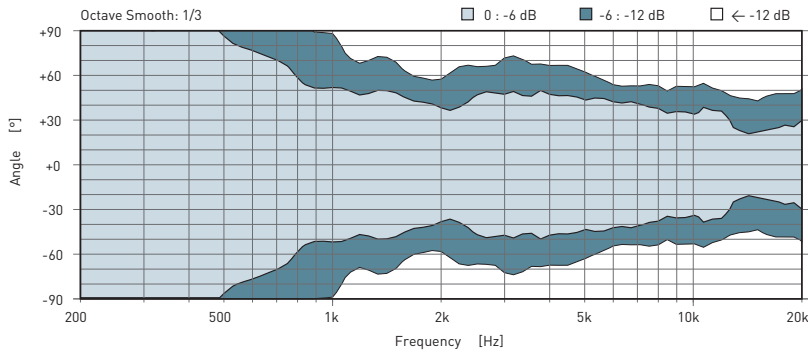

HORIZONTAL

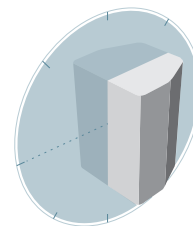
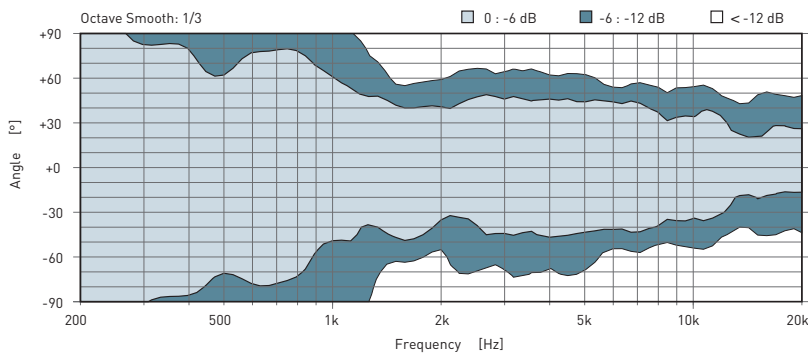

VERTICAL



VEGAS 15cx

COAXIAL LOUDSPEAKER

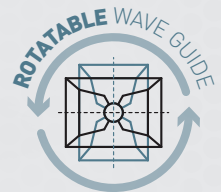

15cx

PERFORMANCE SPECIFICATIONS

| | |
|-----------------------------|-------------------|
| Frequency Response -10 dB | 50 Hz – 20 kHz |
| Nominal Dispersion | 80° x 60° (H x V) |
| Impedance (Nom/Min) | 8 Ω / 6.5 Ω |
| Watts AES (Continuous/Peak) | 500 W / 2000 W |
| Maximum SPL Output * | 136 dB SPL |

* calculated using +10 dB Crest Factor signal @ 1 m, Free Field

PHYSICAL

| | |
|---------------------|---------------------------------|
| Component Low | 15" woofer |
| Component High | 3" diaphragm compression driver |
| Loading Low | Bass-reflex |
| Loading High | Coaxial rotatable moulded horn |
| Connectors | 2 x NL4 in parallel Pins 1+/1- |
| Cabinet Material | Baltic birch plywood |
| Cabinet Finish | Black polyurea coating |
| Grill | Epoxy powder coated |
| Installation Points | 4 x M6, 16 x M8 threaded points |
| Pole Mount | 35 mm socket |
| Height | 680 mm – 26 25/32" |
| Width | 450 mm – 17 23/32" |
| Depth | 390 mm – 15 11/32" |
| Weight | 22.5 kg – 49.6 lb |



VEGAS₂₄

ULTRA COMPACT LOUDSPEAKER



FEATURES

- › Ideally suited for wide-coverage applications requiring a small, low profile cabinet
- › High quality compression driver (1.5" voice coil) coupled with proprietary wave-guide
- › Excellent spoken word intelligibility
- › High SPL capability relative to size and weight (122 dB SPL @ 1 m)
- › Extraordinary audio fidelity and power handling
- › Wide 150° dispersion pattern with detailed high frequency bandwidth
- › Two 4-inch woofers in a dipolar arrangement provide exceptional horizontal dispersion pattern control
- › Fitted with M6 installation points
- › Two selectable angles for front fill and under balcony applications
- › Multi connector design with NL4 and high current 4-Pole Phoenix
- › Pass-through NL4 allows multiple device parallel connection capability
- › High current Phoenix connector for ease of installation
- › High quality passive network with large inductors and capacitors
- › All Baltic birch wood dovetail joinery construction
- › Black textured polyurea scratch free finish
- › Custom RAL color repainting options
- › Compatible with Outline Openarray 3D acoustic simulation software
- › Designed, sourced and manufactured exclusively in Italy

24

DESCRIPTION

VEGAS 24 is an ultra compact, high power, wide-dispersion externally powered loudspeaker specifically designed for under balcony fill, front fill and delay applications for professional sound reinforcement and installations of any size. This high bandwidth, low profile device is optimized for superb vocal and instrument intelligibility and clarity due to its industry leading Common Intelligibility Scale (CIS) rating. Only high quality Italian made components are used in this low distortion loudspeaker. A special waveguide loaded design provides and enhances the desired precedence required for localization and other psychoacoustic effects often specified for quality installations. Four to eight devices may be used in parallel, saving installation costs. The compatible voicing design allows easy pairing with all other Outline loudspeakers. The high frequency section features a 1.5"-inch compression driver (1" exit) coupled to an Outline proprietary waveguide to insure exceptional intelligibility. Lows utilize two 4-inch woofers (1-inch voice coil) employing a bass reflex loaded system. The cabinet is coated with a high-tech black textured polyurea scratch free finish. Custom RAL color repainting options are available for installations with specific cosmetic requirements. The ultra compact, high tensile strength, lightweight enclosure is equipped with two NL4 and a 4-pin Phoenix connector package that offers production quality pass thru for multiple loudspeakers in parallel.

FACILITIES

Conference Rooms
Clubs/Lounges
Bars/Pubs
Retail Stores
Shopping Centers
Malls
Music Groups
Schools

Railway Stations
Airports
Hotels
Fitness Centers
Churches
Sports Facilities
Auditorium

APPLICATIONS

Under Balcony
Foreground Music Systems
Background Music Systems
Paging Systems
Main PA
Delay & Fill
Stage Front Fill

PERFORMANCE SPECIFICATIONS

| | |
|-----------------------------------|--------------------|
| Frequency Response -10 dB | 120 Hz – 22 kHz |
| Nominal Dispersion | 150° x 90° (H x V) |
| Impedance (Nom/Min) | 16 Ω / 10.5 Ω |
| Watts AES (Continous/Peak) | 160 W / 640 W |
| Maximum SPL Output * | 122 dB SPL |

** calculated using +10 dB Crest Factor signal @ 1 m, Free Field*

PHYSICAL

| | |
|----------------------------|-----------------------------------|
| Component Low | 2 x 4" woofer |
| Component High | 1.5" diaphragm compression driver |
| Loading Low | Band-pass |
| Loading High | Moulded horn |
| Connectors | 2 x NL4 PAR Pins 1+/1-, 4PIN PHX |
| Cabinet Material | Baltic birch plywood |
| Cabinet Finish | Black polyurea coating |
| Grill | Epoxy powder coated |
| Installation Points | 8 x M6 threaded points |
| Pole Mount | N/A |
| Height | 148 mm – 5 27/32" |
| Width | 280 mm – 11 1/32" |
| Depth | 120 mm – 4 23/32" |
| Weight | 3.1 kg – 6.8 lb |

VEGAS 24

DIMENSIONS

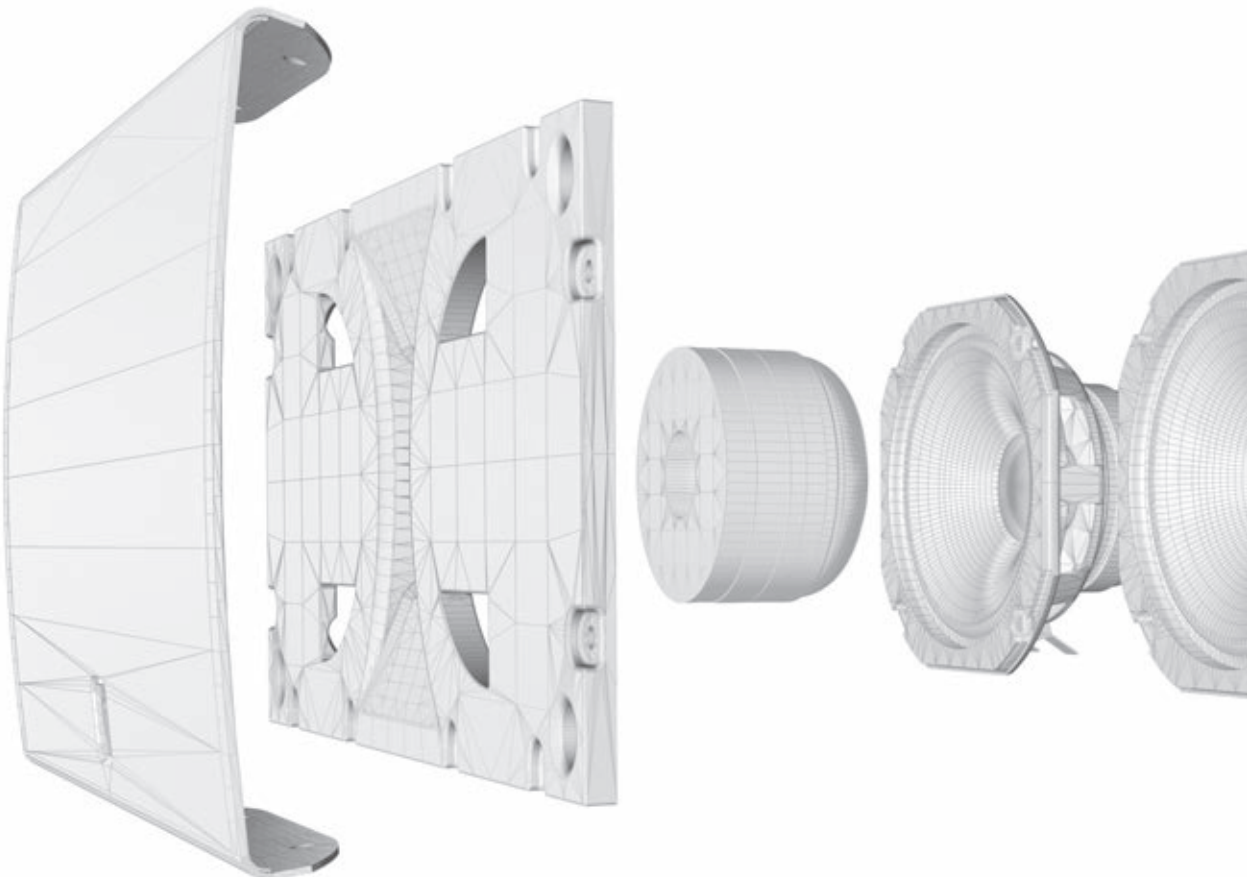
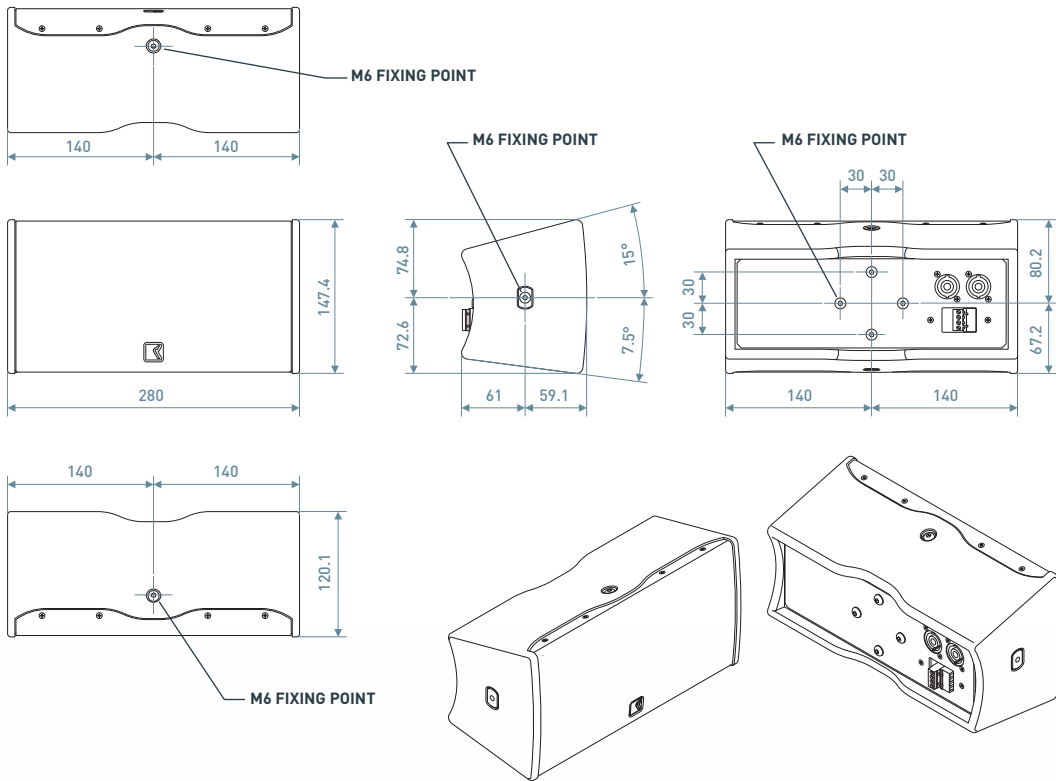

BEAMWIDTH

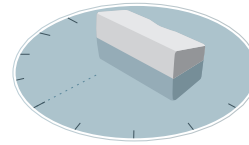
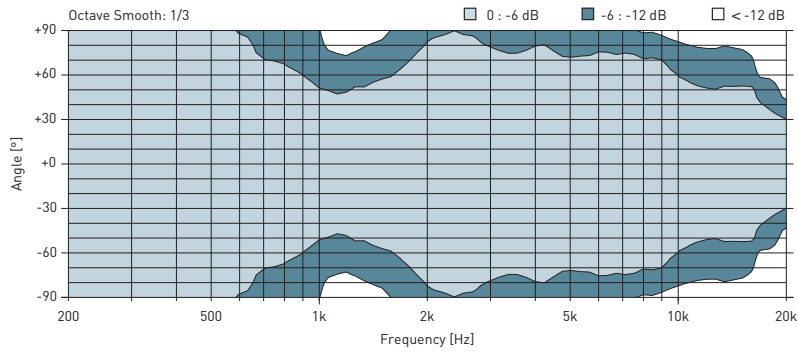

HORIZONTAL

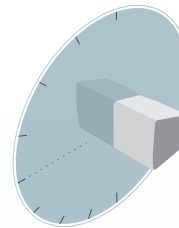
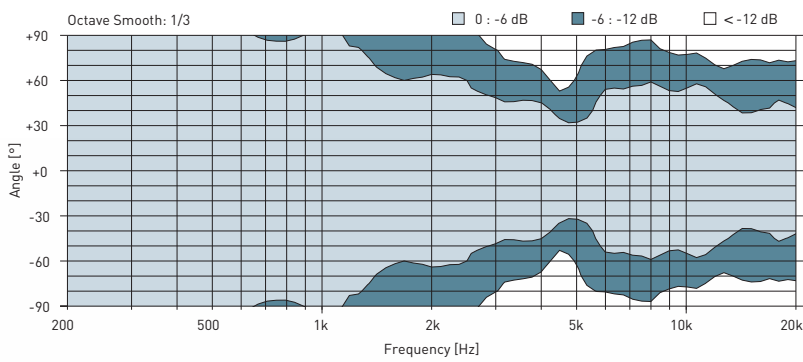

VERTICAL

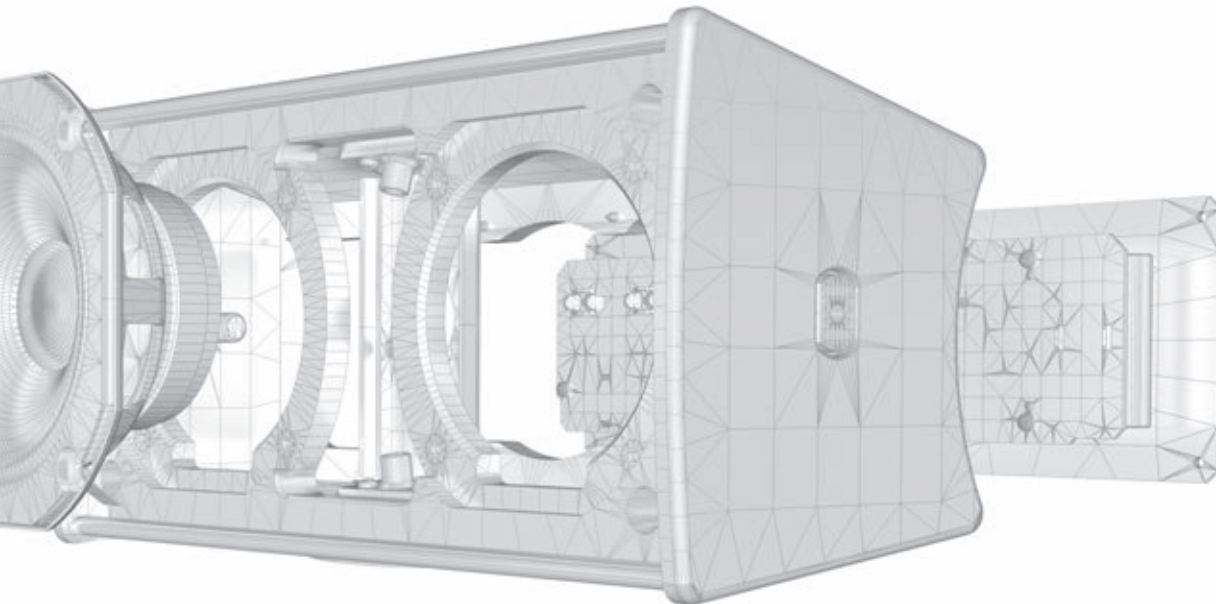



VEGAS 6.5

SUPER COMPACT LOUDSPEAKER



FEATURES

- › Super-Compact loudspeaker designed for mobile and fixed installation applications
- › High-efficiency 6.5" LF transducer and a 1" horn loaded compression driver
- › High SPL (122 dB SPL short-term peak @ 1 m)
- › High spoken word "projection" for precise reproduction with high intelligibility
- › Exceptional power capability in a compact and lightweight package (7.5 kg / 16 lb)
- › Multi-connector design with NL4 and high current 4-Pole Phoenix
- › Pass-through NL4 allows parallel connectivity between multiple devices
- › High current Phoenix connector for ease of installation
- › High quality passive network with large inductors and capacitors
- › Controllable via Outline's iP24 DSP device, based on iMode technology
- › Receptacle for fitting support stand, M8 and M6 threaded mounting points
- › Black textured polyurea scratch free finish
- › Custom RAL colour repainting options
- › Vertical and horizontal mounting hardware options
- › Compatible with Outline OpenArray 3D acoustic simulation software
- › Designed, sourced and manufactured exclusively in Italy

DESCRIPTION

Vegas 6.5 is a super-compact loudspeaker designed for mobile and fixed installation applications, especially where high continuous SPLs need to be delivered in an environment where space is at a premium. The enclosure design includes integral mounting hardware, compatible with various separately available mounting brackets. These provide a huge range of installation options for the unit. Vegas 6.5's physically small enclosure belies its power. A high-efficiency 6.5" LF transducer and a 1" horn-loaded compression driver produce a maximum output of 122 dB SPL, and the unit will comfortably exceed the performance of most comparable devices loaded with 8" LF drivers. The extraordinary power handling capability of this Vegas fixture means that it can comfortably and reliably reproduce a range of program material with very low distortion and power compression. It is particularly well suited to spoken-word reproduction, as its power and projection deliver class-leading intelligibility, especially in the near/mid-field. Vegas 6.5 delivers a very cost-effective installation solution, making very efficient use of amplified channels. It's also available in a wide range of colours, meaning installers can exactly match the speaker to the decor of a location where required. The cabinet is coated with a high-tech black textured polyurea scratch-free finish, which forms an elastoplastic protection that interacts with the plywood structure to further increase the cabinet's sturdiness and vibration absorption capacity.

FACILITIES

Retail stores
 Industrial, commercial
 and leisure projects
 Pubs, bars and cafes
 Small theatrical installations
 Schools
 Malls
 Hotels

Airports
 Railway stations
 House of worship
 Auditorium
 Shopping centres
 Conference rooms
 Sport facilities

APPLICATIONS

Under Balcony
 Foreground Music Systems
 Background Music Systems
 Paging Systems
 Main PA
 Delay and fill
 Stage front fill

PERFORMANCE SPECIFICATIONS

| | |
|------------------------------------|--------------------|
| Frequency Response -10 dB | 65 Hz – 19 kHz |
| Nominal Dispersion | 100° x 60° (H x V) |
| Impedance (Nom/Min) | 8 Ω / 6.7 Ω |
| Watts AES (Continuous/Peak) | 200 W / 800 W |
| Maximum SPL Output * | 122 dB SPL |

** calculated using +10 dB Crest Factor signal @ 1 m, Free Field*

PHYSICAL

| | |
|----------------------------|----------------------------------|
| Component Low | 6.5" woofer |
| Component High | 1" diaphragm compression driver |
| Loading Low | Bass-reflex |
| Loading High | Moulded horn |
| Connectors | 2 x NL4 PAR Pins 1+/1-, 4PIN PHX |
| Cabinet Material | Baltic birch plywood |
| Cabinet Finish | Black polyurea coating |
| Grill | Epoxy powder coated |
| Installation Points | 2 x M8, 4 x M6 threaded points |
| Pole Mount | N/A |
| Height | 350 mm – 13 25/32" |
| Width | 220 mm – 8 21/32" |
| Depth | 245 mm – 9 21/32" |
| Weight | 7.5 kg – 16.5 lb |

DIMENSIONS

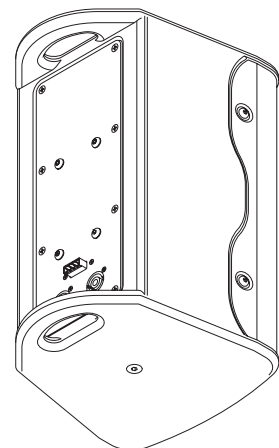
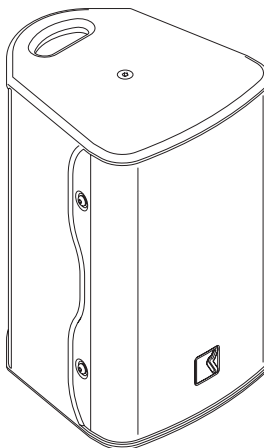
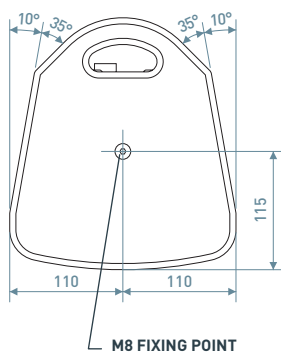
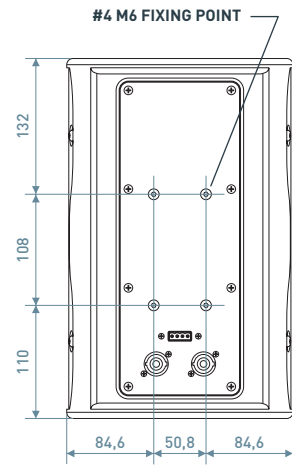
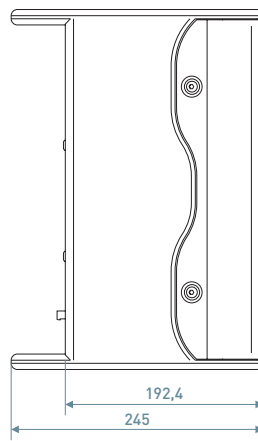
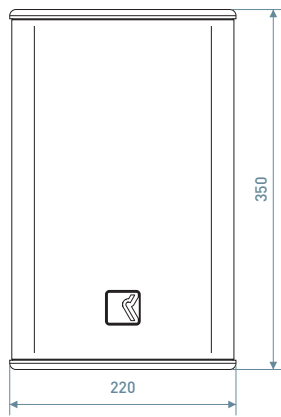
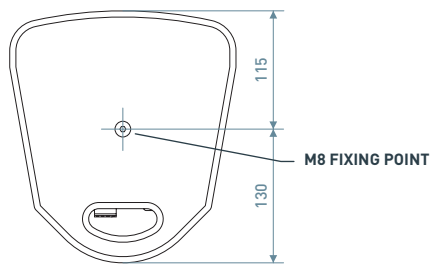

BEAMWIDTH

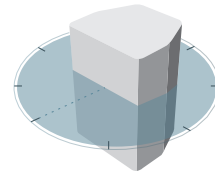
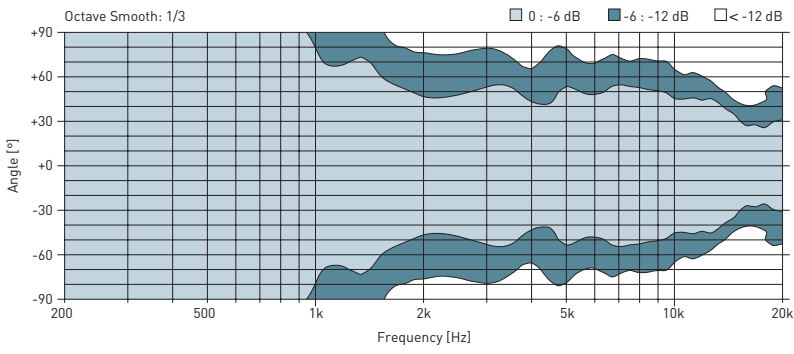

HORIZONTAL

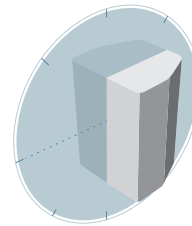
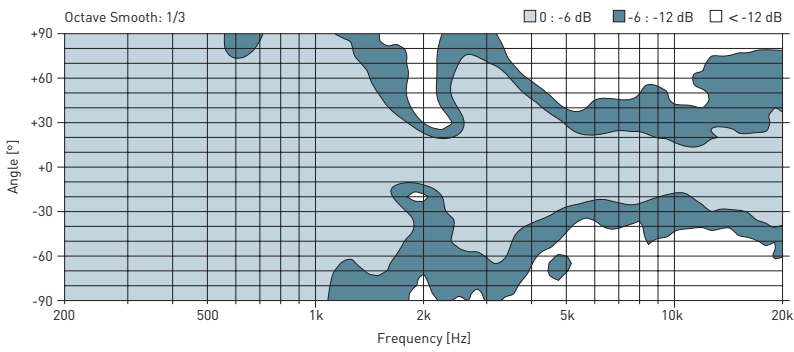

VERTICAL





VEGAS 10 12 15

FEATURES

- › Natural, uncoloured audio performance
- › Predictable and accurate HF directivity control
- › High SPL capability relative to the size and weight of the cabinet
- › Two-way format (8 Ohms nominal) with built-in passive crossover
- › Internal crossover network featuring top grade components
- › Rotatable waveguide (90° x 60°) – on Vegas 10, 12 and 15
- › Multi alignment horn assembly and cabinet design allowing use as stage monitors
- › Choice of three full-range models in varying sizes providing design flexibility
- › Contemporary and original Outline design
- › Internal cabinet bracing to ensure maximum rigidity and prevent coloration due to internal resonance
- › Fitted with multiple M8 and M6 rigging points as standard
- › Custom RAL colour repainting options
- › Comprehensive choice of mounting hardware available to suit all applications
- › Conceived, designed and manufactured exclusively in Italy
- › Compatible with Outline OpenArray 3D acoustic simulation software

DESCRIPTION

The Vegas full-range two-way enclosures are available with a choice of 10", 12" and 15" low frequency drivers, and all the three models are fitted with a 1.75" compression driver, mounted on a rotatable horn assembly. This, in conjunction with the multi-faceted cabinet design, allows them to be used as floor monitors if required. It also allows for them to be suspended either horizontally or vertically using the integral M8 and M6 rigging points, whilst maintaining the required HF dispersion. The units are fitted with passive crossovers, and manufactured with top grade components (coils with very low resistance and metallized polypropylene capacitors). The compression driver and waveguide are the same on all three models. The rotatable 90° x 60° waveguide offers a great advantage for installation in small rooms, or those with low headroom. This is because the waveguide can be rotated through 90° to ensure required dispersion is achieved regardless of the orientation the cabinet is installed in. The mouth's ample dimensions ensure remarkable directivity control. The shape of the cabinets enable them to be also used as stage monitors.

The technology adopted by Outline in the moulding sector has enabled the company to manufacture horns that are rigid and lighter, with obvious benefits in terms of distortion and lower weight.

For further extension of the bottom end, and therefore greater dynamics, a line of high performance subwoofers is also available.

FACILITIES

Theatres
Auditoriums
Conference rooms
Churches
Cafes
Clubs/Lounges
Bars/Pubs
Shopping centres/Malls

Music groups
Schools
Railways stations
Airports
Sports facilities
Theme parks
Broadcast TV

APPLICATIONS

Main PA
Side Fills
Drum Monitors
Floor Monitors
Delay & Fill
Foreground Music Systems
Background Music Systems
Paging Systems



VEGAS 10

TWO-WAY LOUDSPEAKER

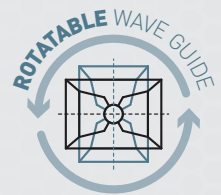

10

PERFORMANCE SPECIFICATIONS

| | |
|------------------------------------|-------------------|
| Frequency Response -10 dB | 60 Hz – 20 kHz |
| Nominal Dispersion | 90° x 70° (H x V) |
| Impedance (Nom/Min) | 8 Ω / 6.2 Ω |
| Watts AES (Continuous/Peak) | 250 W / 1000 W |
| Maximum SPL Output * | 130 dB SPL |

** calculated using +10 dB Crest Factor signal @ 1 m, Free Field*

PHYSICAL

| | |
|----------------------------|------------------------------------|
| Component Low | 10" woofer |
| Component High | 1.75" diaphragm compression driver |
| Loading Low | Bass-reflex |
| Loading High | Rotatable moulded horn |
| Connectors | 2 x NL4 PAR Pins 1+/1- |
| Cabinet Material | Baltic birch plywood |
| Cabinet Finish | Black polyurea coating |
| Grill | Epoxy powder coated |
| Installation Points | 12 x M8, 4 x M6 threaded points |
| Pole Mount | 35 mm socket |
| Height | 590 mm – 23 7/32" |
| Width | 350 mm – 13 25/32" |
| Depth | 334 mm – 13 5/32" |
| Weight | 15.5 kg – 34.2 lb |

DIMENSIONS

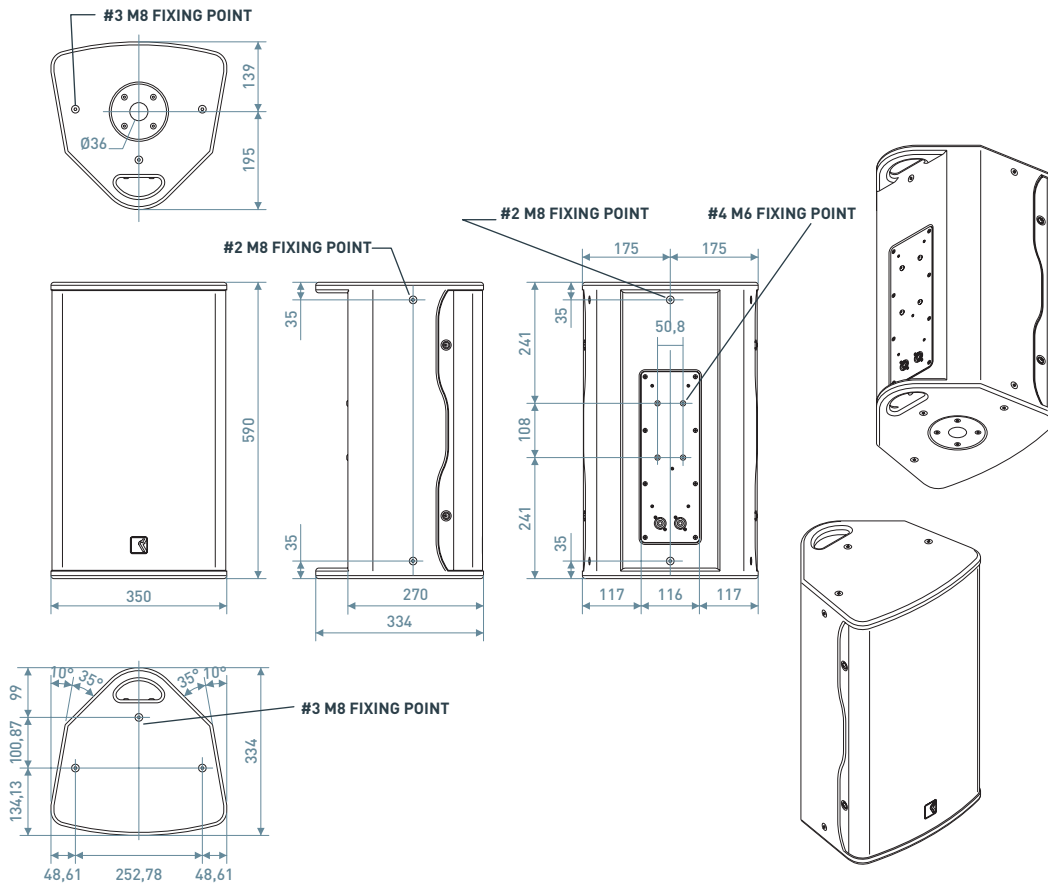

BEAMWIDTH

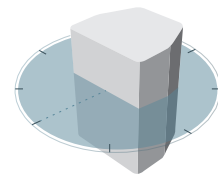
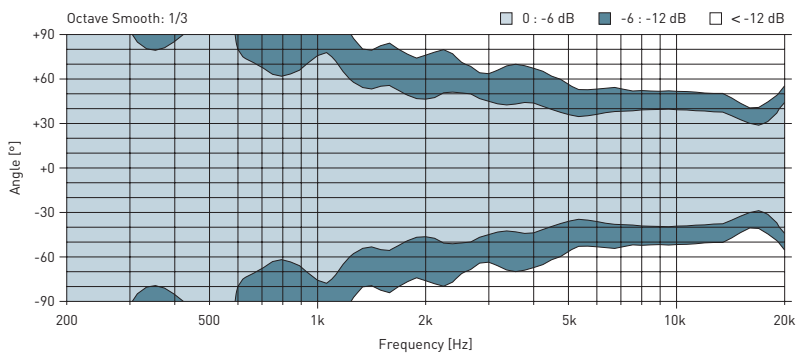

HORIZONTAL

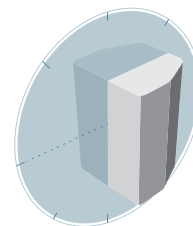
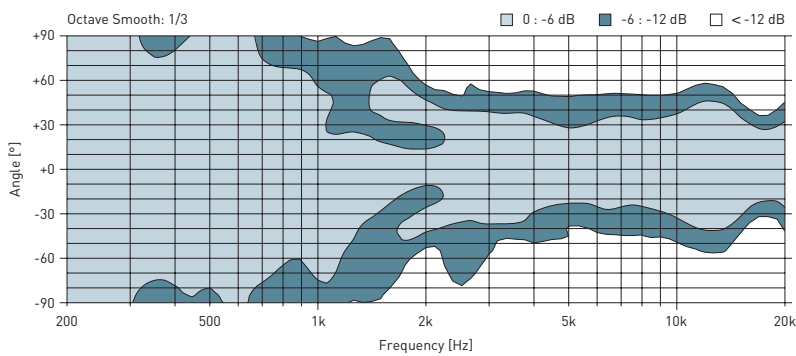

VERTICAL



VEGAS 12

TWO-WAY LOUDSPEAKER

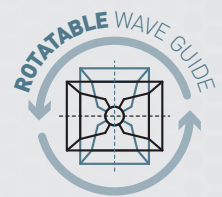

12

PERFORMANCE SPECIFICATIONS

| | |
|-----------------------------|-------------------|
| Frequency Response -10 dB | 55 Hz – 20 kHz |
| Nominal Dispersion | 90° x 70° (H x V) |
| Impedance (Nom/Min) | 8 Ω / 7 Ω |
| Watts AES (Continuous/Peak) | 300 W / 1200 W |
| Maximum SPL Output * | 131 dB SPL |

* calculated using +10 dB Crest Factor signal @ 1 m, Free Field

PHYSICAL

| | |
|---------------------|------------------------------------|
| Component Low | 12" woofer |
| Component High | 1.75" diaphragm compression driver |
| Loading Low | Bass-reflex |
| Loading High | Rotatable moulded horn |
| Connectors | 2 x NL4 PAR Pins 1+/1- |
| Cabinet Material | Baltic birch plywood |
| Cabinet Finish | Black polyurea coating |
| Grill | Epoxy powder coated |
| Installation Points | 12 x M8, 4 x M6 threaded points |
| Pole Mount | 35 mm socket |
| Height | 670 mm – 26 3/8" |
| Width | 396 mm – 15 19/32" |
| Depth | 341 mm – 13 14/32" |
| Weight | 17.7 kg – 39 lb |

DIMENSIONS

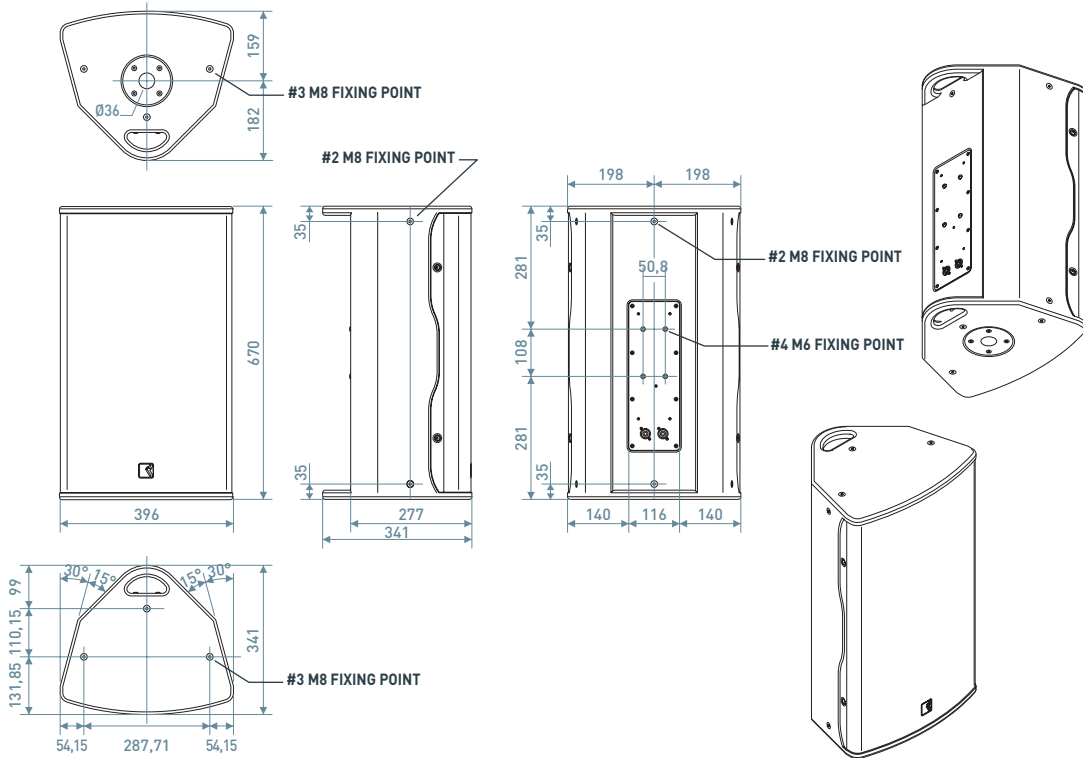

BEAMWIDTH

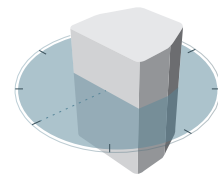
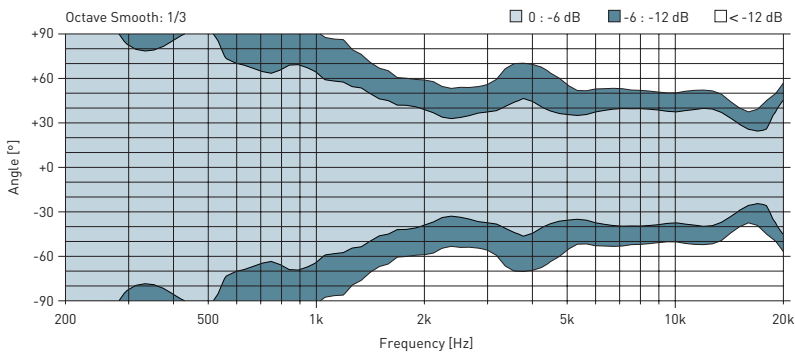

HORIZONTAL

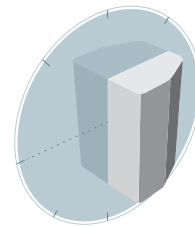
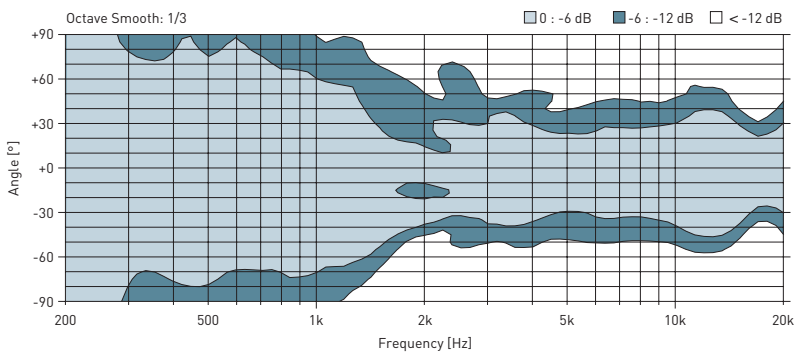

VERTICAL



VEGAS 15

TWO-WAY LOUDSPEAKER

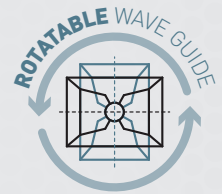

15

PERFORMANCE SPECIFICATIONS

| | |
|-----------------------------|-------------------|
| Frequency Response -10 dB | 53 Hz – 20 kHz |
| Nominal Dispersion | 80° x 70° (H x V) |
| Impedance (Nom/Min) | 8 Ω / 7.3 Ω |
| Watts AES (Continuous/Peak) | 400 W / 1600 W |
| Maximum SPL Output * | 132 dB SPL |

* calculated using +10 dB Crest Factor signal @ 1 m, Free Field

PHYSICAL

| | |
|---------------------|------------------------------------|
| Component Low | 15" woofer |
| Component High | 1.75" diaphragm compression driver |
| Loading Low | Bass-reflex |
| Loading High | Rotatable moulded horn |
| Connectors | 2 x NL4 PAR Pins 1+/1- |
| Cabinet Material | Baltic birch plywood |
| Cabinet Finish | Black polyurea coating |
| Grill | Epoxy powder coated |
| Installation Points | 12 x M8, 4 x M6 threaded points |
| Pole Mount | 35 mm socket |
| Height | 750 mm – 29 17/32" |
| Width | 450 mm – 17 23/32" |
| Depth | 390 mm – 15 11/32" |
| Weight | 25.8 kg – 56.9 lb |

DIMENSIONS

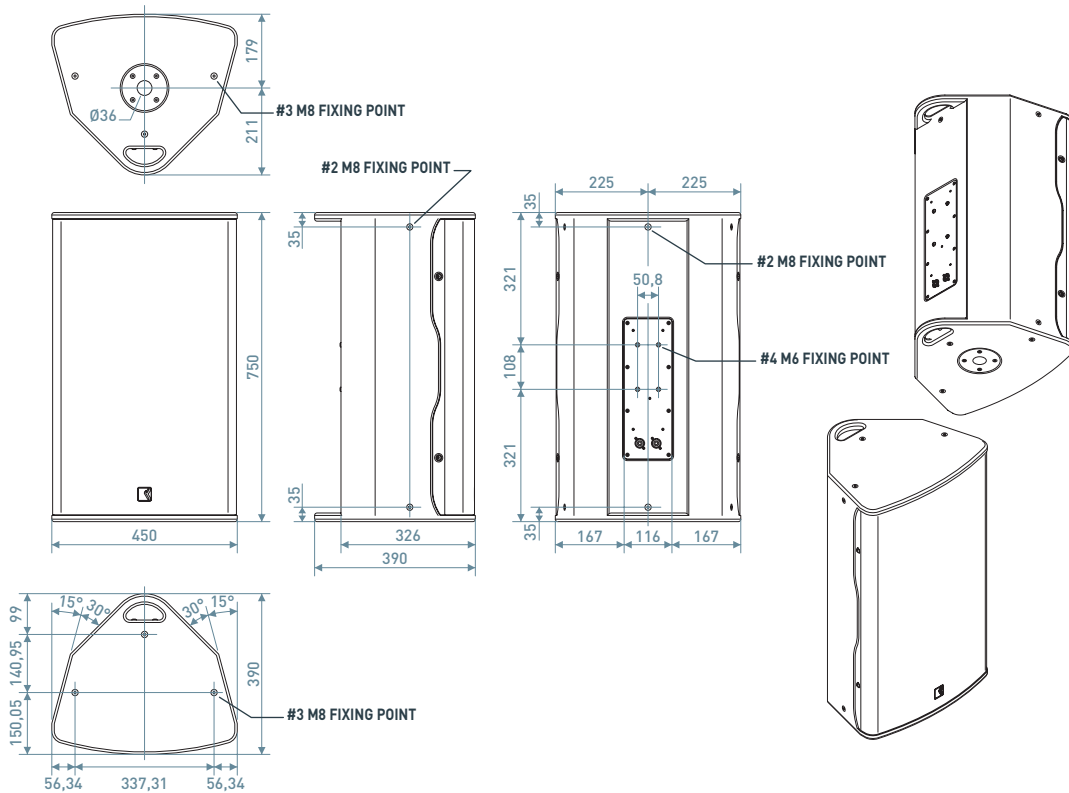

BEAMWIDTH

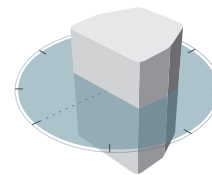
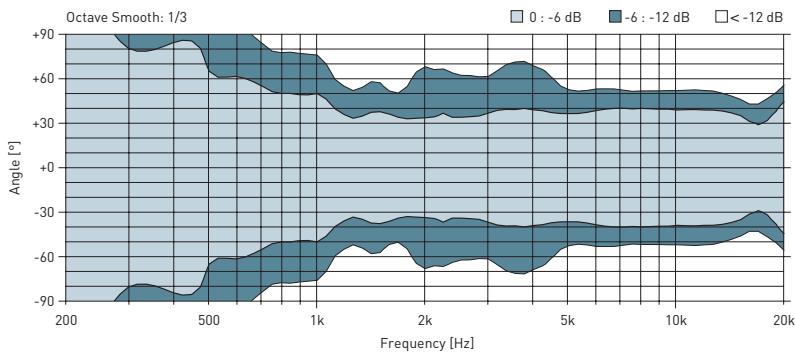

HORIZONTAL

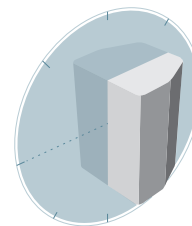
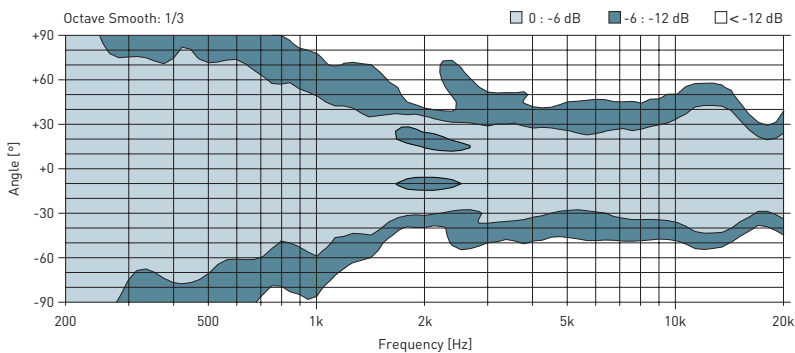

VERTICAL

SYSTEM CONFIGURATIONS

»»» VEGAS 24

1 x iP 24
1 x M2800-4
4 x Vegas 24
2 x SUB 108

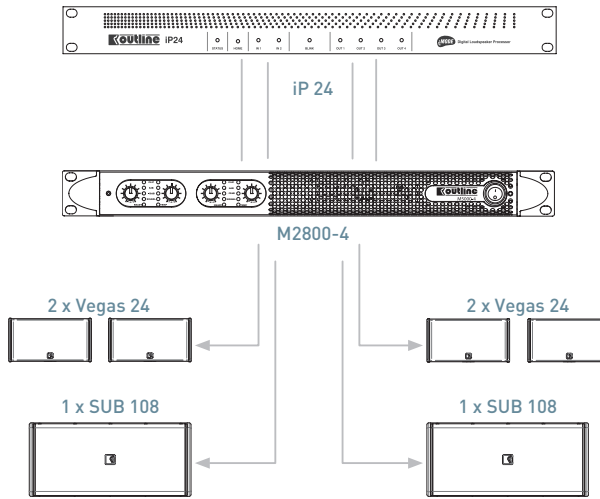

»»» VEGAS 6.5 / 10 / 12

1 x iP 24
1 x M5000-4
8 x Vegas 6.5 / 10 / 12

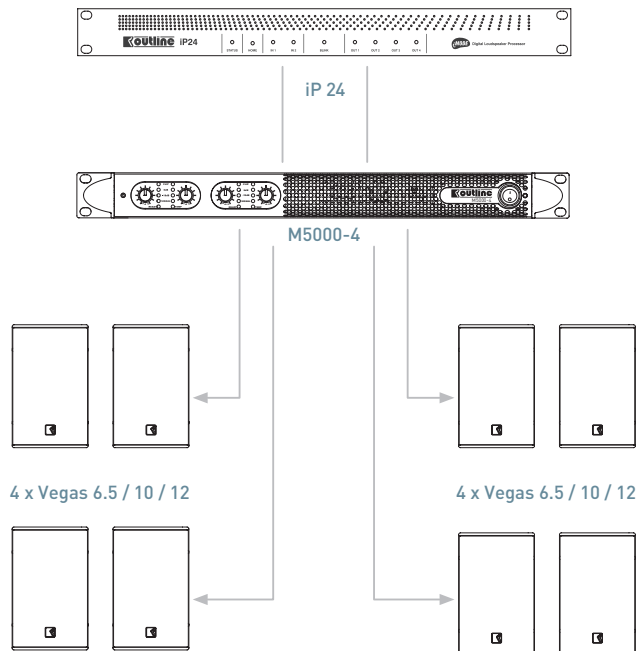

SYSTEM CONFIGURATIONS

VEGAS 8 CX / 12 CX

- 1 x iP 24
- 1 x M5000-4
- 8 x Vegas 8 CX / 12 CX

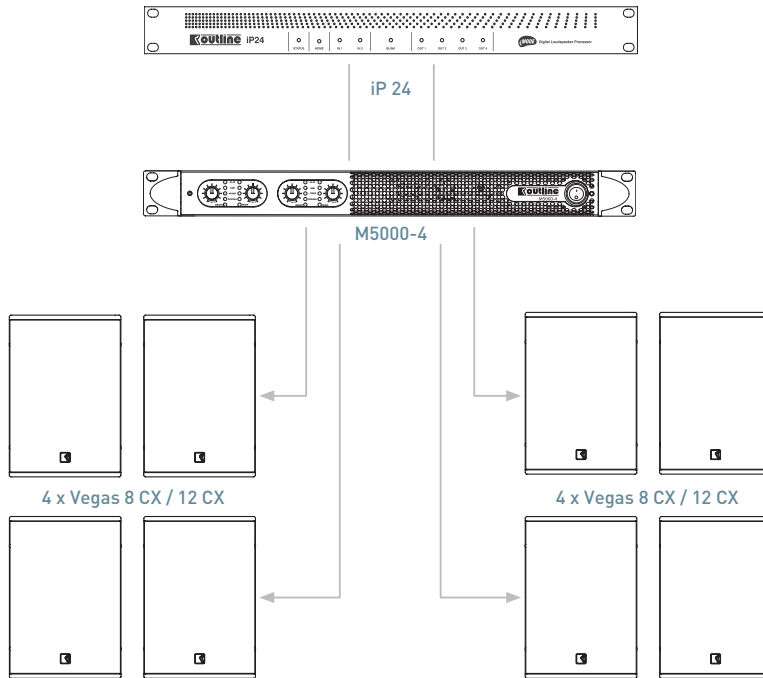

VEGAS 15 / 15 CX

- 1 x iP 24
- 1 x T Five
- 4 x Vegas 15 / 15 CX

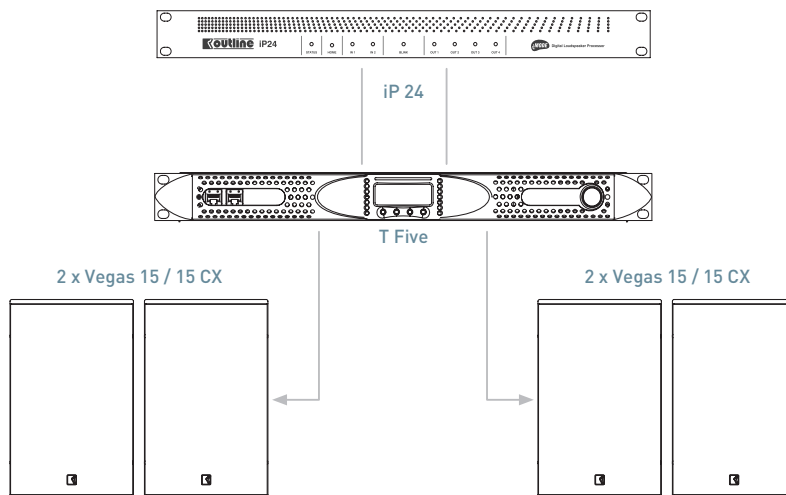

ACCESSORIES

WHH100-B
Wall bracket

Available for:
VEGAS 10, VEGAS 12, VEGAS 15,
VEGAS 12CX, VEGAS 15CX

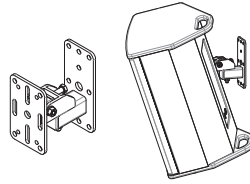

ADAPT36-M8
Steel adaptor to mount
VEGAS 6.5 to a 35 mm pole

Available for:
VEGAS 6.5

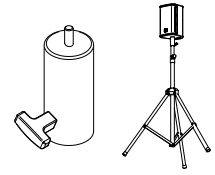

WME-75
Wall bracket

Available for:
VEGAS 6.5, VEGAS 8CX

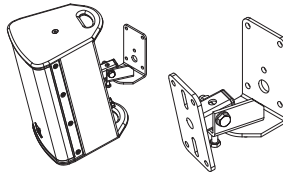

BJB1-V24
Ball joint bracket

Available for:
VEGAS 24

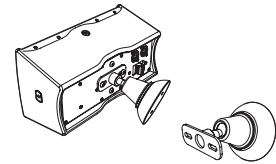

TH100-B
Truss bracket

Available for:
VEGAS 10, VEGAS 12,
VEGAS 15, VEGAS 12CX,
VEGAS 15CX

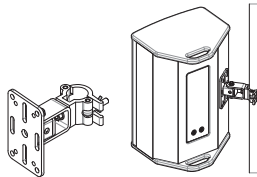

CB-V24
"C"-type bracket

Available for:
VEGAS 24

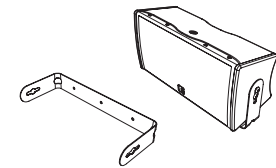

STAND2
Tripod pole

Available for:
VEGAS 10, VEGAS 12,
VEGAS 15, VEGAS 8CX,
VEGAS 12CX, VEGAS 15CX

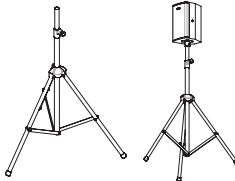

WPCON-01
Weatherproof cable protection

Available for:
VEGAS 10, VEGAS 12, VEGAS 15,
VEGAS 12CX, VEGAS 15CX

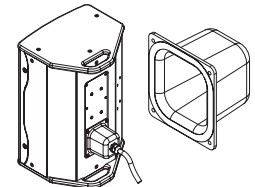

STAND-M20
Telescopic pole

Available for:
VEGAS 10, VEGAS 12,
VEGAS 15, VEGAS 8CX,
VEGAS 12CX, VEGAS 15CX

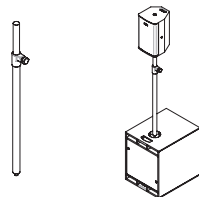

WPCON-02
Weatherproof cable protection

Available for:
VEGAS 6.5, VEGAS 8CX



STAND-ADAPT
Adaptor for two speakers

Available for:
VEGAS 10, VEGAS 12,
VEGAS 8CX, VEGAS 12CX

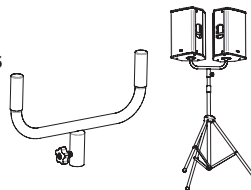

ADJBH-E10
Wall-ceiling horizontal
mounting bracket

Available for: VEGAS 10

ADJBH-E12
Wall-ceiling horizontal
mounting bracket

Available for: VEGAS 12

ADJBH-E15
Wall-ceiling horizontal
mounting bracket

Available for: VEGAS 15

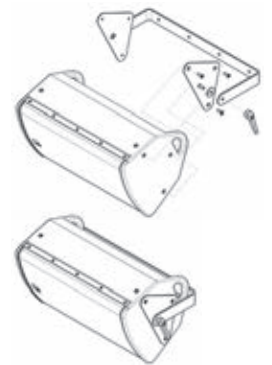

STAND-WALL1
Wall bracket

Available for:
VEGAS 10, VEGAS 12,
VEGAS 15, VEGAS 8CX,
VEGAS 12CX, VEGAS 15CX

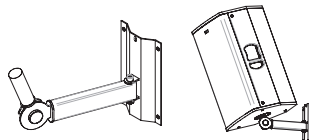

STAND-INCLIN
Pole mount with
gradual inclination

Available for:
VEGAS 10, VEGAS 12,
VEGAS 15, VEGAS 8CX,
VEGAS 12CX, VEGAS 15CX

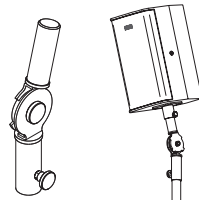

ADJBV-E10
Wall-ceiling vertical
mounting bracket

Available for: VEGAS 10

ADJBV-E12
Wall-ceiling vertical
mounting bracket

Available for: VEGAS 12

ADJBV-E15
Wall-ceiling vertical
mounting bracket

Available for: VEGAS 15

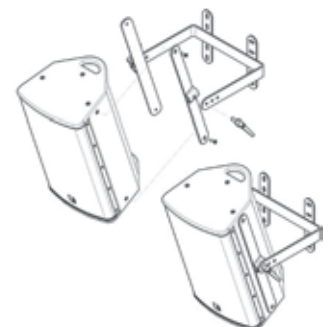

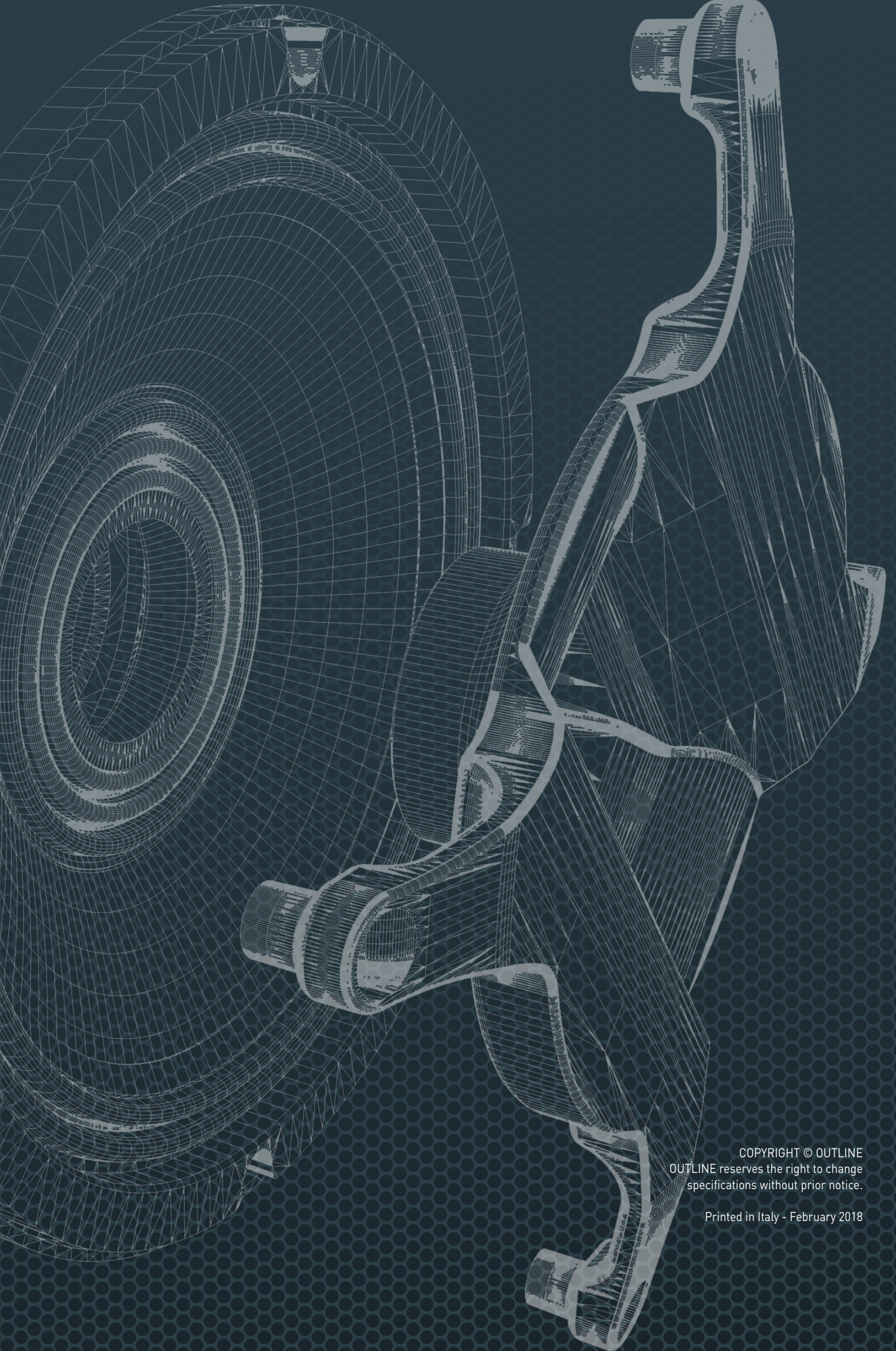

COPYRIGHT © OUTLINE
OUTLINE reserves the right to change
specifications without prior notice.

Printed in Italy - February 2018



OUTLINE S.R.L.
Via Leonardo da Vinci, 56
25020 Flero (Brescia) Italy

Tel. +39 030.3581341
Fax +39 030.3580431
info@outline.it

www.outline.it