

GT

GRAND TOURING OUTLINE



Outline

Outlinearray

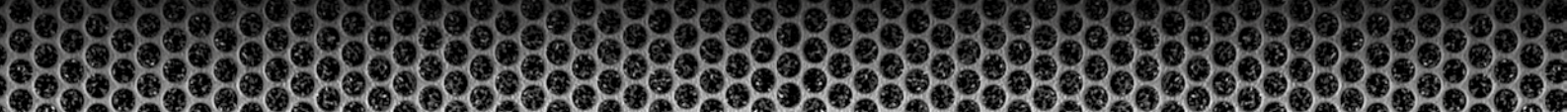

"The GTO was already a winner on paper, due to the box containing superior components: four 3" (HF), four 8" (MF) and two 15" (LF) all in a single enclosure. However, it was only when I worked with the system for the first time in front of a 700,000-strong audience that I realised that the GTO was not only far superior on paper, but also compared with anything else I had ever worked with. It really rocked, providing long-throw coverage never heard before".

ANDREA TAGLIA
FOH engineer of the Italian tenor **Andrea Bocelli**

TABLE OF CONTENTS

Company Profile	3
GTO System Introduction	4-5
GTO System Key Design and Performance Details	6-17
GTO C-12	18-19
GTO-LOW	20
GTO-DF	22
GTO-SUB	24
LIPF 082	26
OPENARRAY Simulation Software	28
Technical Specifications	29 - 31



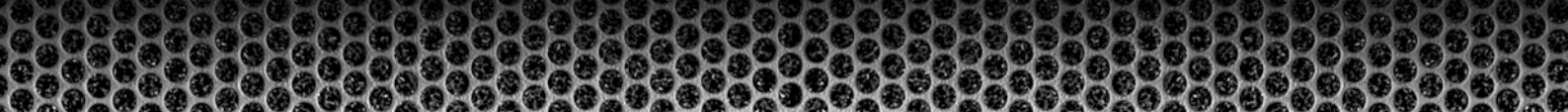

JUREK TABOROWSKI

Gigant Sound Letus, one of Eastern Europe's leading production companies - www.gigantsound.com.pl



"Dowlen Sound's partnership with Outline has been one to treasure. Their products are designed and produced with only their customers best interest in mind and their staff is there to support you every step of the way. We are extremely excited to be involved with such an amazing company and products they manufacture."

BRET B. DOWLEN and ERIC SATRE,

Dowlen Sound Inc., Arvada, Colorado - www.dowlensound.com



OUR COMPANY, OUR PEOPLE, OUR PARTNERS

Outline s.r.l. is, and has always been, a privately-owned company. We do not have any institutional or corporate shareholders, neither do we rely on venture capital or other investors who might influence us or our decisions. All the owners of Outline are directly involved in the day-to-day business of our company.

What does this mean to you? First and foremost it means that any current or prospective client is free to speak and meet with the people who control the business: the people who actually make the strategic decisions about products, markets, technology, distribution, long-term direction, sales, marketing and any other topic that affects us and our partners.

Our management and administration structure is lean and flexible because we want to stay free of unnecessary barriers between us and our customers. We will never expect a customer to communicate with us via layers of middle management, corporate climbers or poorly-informed sales people.

This approach allows us to compete effectively with manufacturers who are larger than us, because they usually do not have the ability to work as closely as we do with our distributors and clients.

The fact that we are agile and able to react quickly when needed gives us and our clients all over the world a major operational advantage.

Our international sales and distribution partners are chosen with great care, and many of them have worked with us for decades. When you speak with them you speak with us, and they are fully empowered to represent our company and products in their respective territories.

Nothing is more important to us than our customers.

In a world dominated by huge, faceless corporations, our customers enjoy their relationships with us because we are accessible to them, always ready to listen, learn and create new opportunities for us to grow together.

OUTLINE HQ FLERO, Brescia, IT





GT GRAND TOURING OUTLINE

The modern production rental market is tough. To succeed in this competitive market you need all the advantages you can get, and choosing the right equipment partners is critical. There are many influences that inform that choice and ultimately only you can decide what is best for your business.

At Outline we work hard to stay in touch with the touring sound industry, and to subsequently reflect that understanding in our designs. We design and manufacture exclusively for professional audio, focusing our energies on serving the industry we know well, by delivering well thought-out products that provide real-world commercial advantages to owners and users.

For example, our view is that a loudspeaker system designed for use in a live sound environment should be as transparent and neutral as possible, i.e. it has little or no distinctive colouration anywhere within its coverage area, and at any SPL within its operating parameters.

This allows sound engineers and their system technicians to deliver the on-stage sound to the audience exactly as they want it to be, without having to 'fight' the PA system.

This in turn means that a good loudspeaker system should

be equally suitable for all types of amplified audio material, from maximum-loudness rock 'n roll in arenas to subtle spoken word in theatres. This flexibility contributes hugely to its rent-ability and consequently to your income.

We also believe that the various components of a modern loudspeaker system should provide the designer and operator with a 'toolbox' that allows them to create modular packages that are appropriate for virtually any application.

This means delivering a suite of products including the loudspeaker elements themselves, plus advanced prediction and analysis software, powerful DSP-driven system controllers and appropriate power amplifiers.

Using a system that offers consistently predictable performance reduces setup time, reduces the need to carry extra equipment and also the crew necessary to deploy it. Perhaps most importantly, we believe that every possible design parameter of the system should contribute to its efficient use and thus make it an effective business tool.

We never lose sight of the fact that our clients are commercial operations who need to justify their investments against the returns they will achieve.

GTO: WHAT IS IT AND WHO IS IT FOR?

Outline's concept for GTO is to produce a large format line-source loudspeaker system that is flexible, adaptable, easy to use and which provides audio performance that meets the demands of the most discerning engineers, rental companies and production managers.

Its advanced acoustic design incorporates much of the experience we have accumulated in almost 40 years of designing and building loudspeaker systems. GTO is an acronym for Grand Touring Outline, which describes our concept of a system engineered specifically for large-scale sound reinforcement applications.

The GTO system design started, not with a product idea, but with research into customer applications. We went to some of the key UK and US sound rental companies with a question:

What do you, your engineers, production managers and other clients want from a major concert loudspeaker system?

Their experience and market knowledge combined with our technical and design skills to produce what we believe to be one of the best-sounding and commercially viable concert loudspeaker systems available today.

LIKE A LARGE "BUTTERFLY"

In 2002 we launched the Butterfly system which contained a number of unique Outline engineering concepts, and which has brought us many new friends and customers around the world.

GTO benefits from a process of natural evolution which

retains the basic design principles, proven within the Butterfly project, and expands them into a new system which provides greater SPL, more control, improved resolution, faster transient response and unrivalled uniformity in long-distance projection.



V-POWER CONCEPT

One of the essential design elements retained from Butterfly is the V-shaped front baffle, (The Outline V-Power Concept) for which Outline was awarded an international design patent in 2002.

This ground-breaking concept allows individual sound sources to be positioned, when coupled in an array, much closer together than in conventional line-source systems.

This facilitates superior acoustical coupling between high-frequency modules thus producing a smooth yet extended HF response.

It also creates the ideal 'unbroken baffle' shape through an array which minimises diffraction and deterioration of the mid-high frequencies, thus contributing to the far-field performance of the system.



JAMES RIVER ASSEMBLY CHURCH – Ozark, USA

10 LOUDSPEAKERS IN 340 LITRES

Modern loudspeaker systems need to be as compact as possible to provide efficiency of operation and transport, yet still deliver extremely high SPLs.

Our design solution to this engineering problem with GTO is to populate a compact cabinet (volume of just 340 litres - 74.79 gals) with no less than ten individual transducers.

This design produces a very large surface area of sound-producing elements (diaphragms and cones), all working together within a unique internal design that guarantees phase coherence between component groups at the exit point of the cabinet.



A COMBINATION OF STRENGTH AND LIGHT WEIGHT

Contemporary concert loudspeaker systems need to be light as well as compact. Despite the very high concentration of individual transducers within a GTO cabinet, we have managed to keep the weight down to just 96 kg (212 lb).

The design contains a number of weight-saving components, but the greatest contribution to this success is the use of a

space-age aluminium alloy from the aerospace industry, which we have used for the integrated flying hardware, in preference to steel.

This innovation reduces the per-cabinet weight of the hardware by 66%, yet is strong enough to fly up to 24 GTO cabinets with a total weight of 2.4 tonnes (2.36 tons).



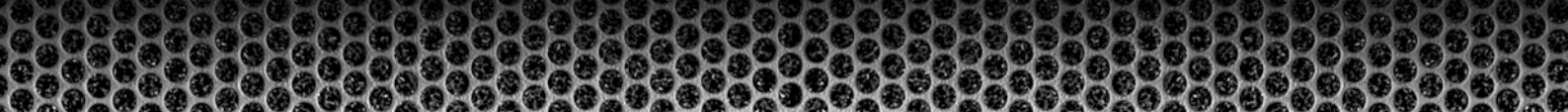

GTO FAMILY MAIN FLYING FRAMES

FRM-GT02

The GTO main flying frame is an 'intelligent' component of the system, designed to be quickly configurable according to need, and thus eliminating the necessity to carry different types of flying hardware on the road. It is reversible, designed so that the choice of extreme upward or downward aiming is determined by which side faces forward. It is also possible to stack a small array of loudspeakers on its top for upfill purposes using a dedicated accessory. Its design allows it to suspend both straight and J-shaped hangs of up to 24 GTO / GTO-LOW elements (2.4 tons), by integrating a cantilever arm that is deployed either in front of or behind the main frame depending on the required aiming. Weight: 107 kg / 236 lb.

01.



01. **FRM-GTO-LW** Lightweight flybar for GTO loudspeaker array family. Weight: 50 kg / 110 lb. Suitable for up to twelve GTO C-12 units. To be rigged by one single 1-ton motor or to be stacked (using a pair of V616 adjustable feet).

TROLLEY XVI Trolley housing two lightweight flybars FRM-GTO-LW. Including one strap 3 m long to hold the lightweight flybars.

02. **FRM-GT02** GTO reversible main frame to rig up to 24 GTO with two motors. Weight: 107 kg / 236 lb.

03. **FC-FRMGTO** Flight case for a single GTO main frame.

04. **SCAP-TR XVI** Weather protection cover for two FRM-GTO-LW lightweight flybars housed on trolley XVI.

FRM-GTO-LW LIGHTWEIGHT FLYBAR

Outline's design team presents a new lightweight flybar (50 kg / 110 lb). It will allow up to twelve GTO C-12 or up to nine GTO elements to be flown from a single 1-ton flying point whilst staying within the standard safe working load conditions.

The FRM-GTO-LW is also designed for "stacked" use: this practical function is useful in all cases in which it is decided to install the line-source system on the floor (e.g. on stages). Using specific stabilizer feet (V616), it is also possible to aim the stacked system at the audience with the necessary inclination.

02.



03.



04.



HIGH-PRECISION AIMING

The splay angle between GTO cabinets is adjustable between 0° and 5° in 0.5° increments, with the addition of a 0.25° position intended for the uppermost cabinets in an array to provide additional control in far-field performance.

Since the splay angle between cabinets affects the physical distance between drive units, the overall performance of

a line-source system demands precise control over these parameters.

A goniometer (a splay angle indicator), which is integral to the cabinet flying hardware, allows precise adjustment of the angle between individual cabinets which is then locked by insertion of a captive steel pin.



SUMMERFEST - The World's Largest Music Festival - Milwaukee, USA



ON THE ROAD

One of the factors that contributes to its low overall weight and easy handling is the fact that GTO is extremely compact, especially when compared to its output power.

A GTO cabinet measures just 112 cm (44.09 inches) wide, 46 cm (18.11 inches) high and 65 cm (25.59 inches) deep, including flying hardware.

This of course provides advantages in crew requirements, transportation and storage, enhancing the efficient use of the system in touring applications.

A dedicated dolly fitted with super-heavy-duty wheels provides ideal storage and transportation for blocks of three GTO cabinets.



HF SECTION – HIGH FREQUENCY POWER AND CONTROL

One of the key advantages of a correctly-designed and deployed line source system over a point-source system of comparable power is the intelligibility performance over long distances. Frequencies in the mid-high range carry the majority of the 'information' that is critical to intelligibility and so are vital to overall system performance.

The GTO system uses a patented Double Parabolic Reflective Waveguide (DPRWG) devices which provides unmatched control over these frequency bands. This unique design provides extraordinary far-field performance whilst retaining the original timbre and naturalness of the source.

For detailed information on this Outline patented technology please consult the White Paper published by our senior designer Guido Noselli.

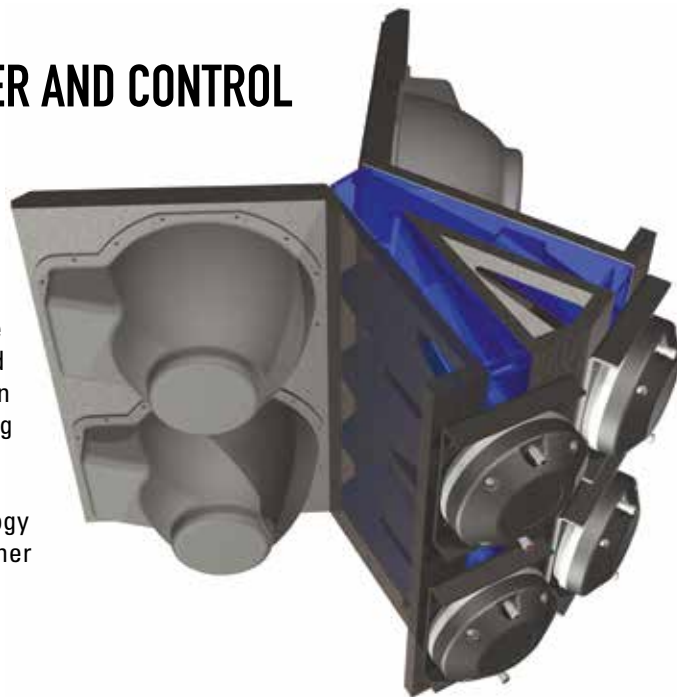

FOUR TIMES THE DRIVE

GTO contains not one but four DPRWG devices, each driven by a 3-inch diaphragm (1.4-inch throat) compression driver.

The huge combined power of these devices is channelled and precisely directed through a single output slot which, through another Outline design, occupies the full height of

the cabinet allowing more controllable acoustic coupling with adjacent cabinets.

This combination of transducers, waveguides and exit aperture is the result of more than two years intensive research, investment and testing - but the results are stunning.



PATTERN CONTROL

GTO

HORIZONTAL BEAMWIDTH

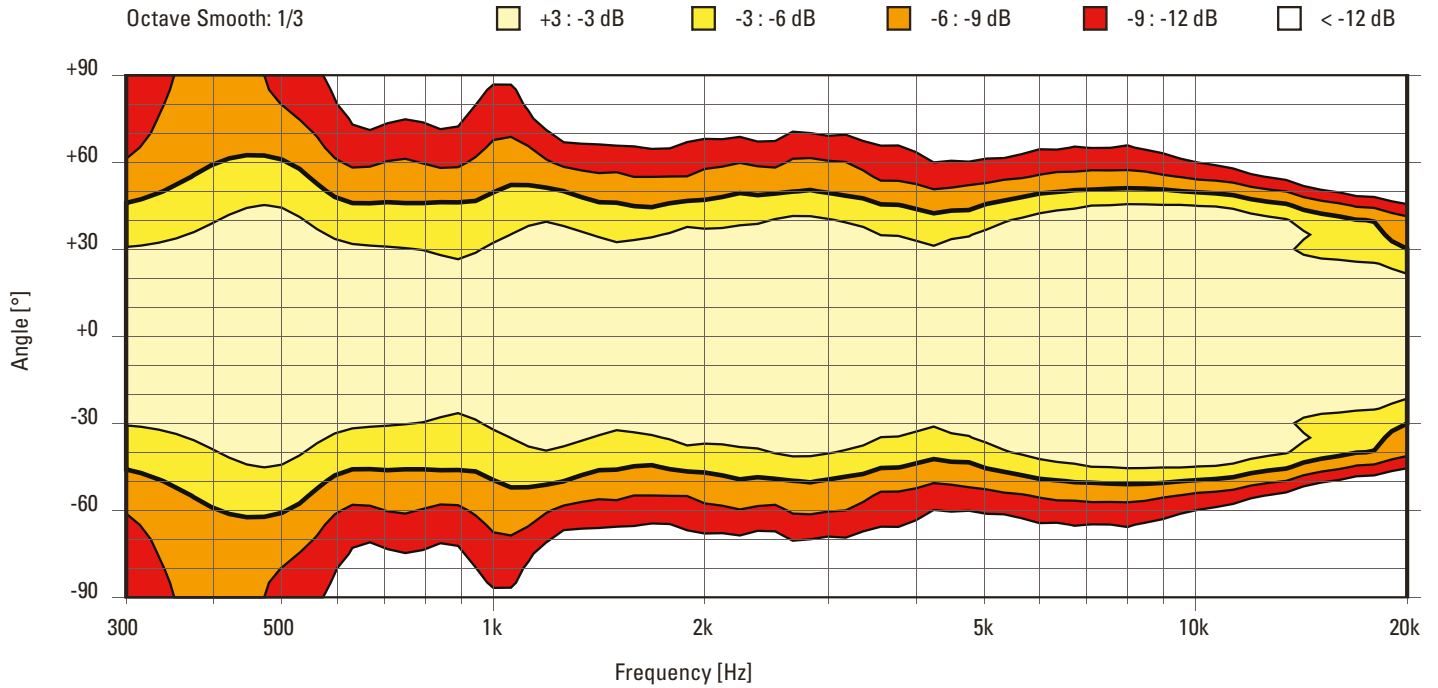

GTO

VERTICAL BEAMWIDTH

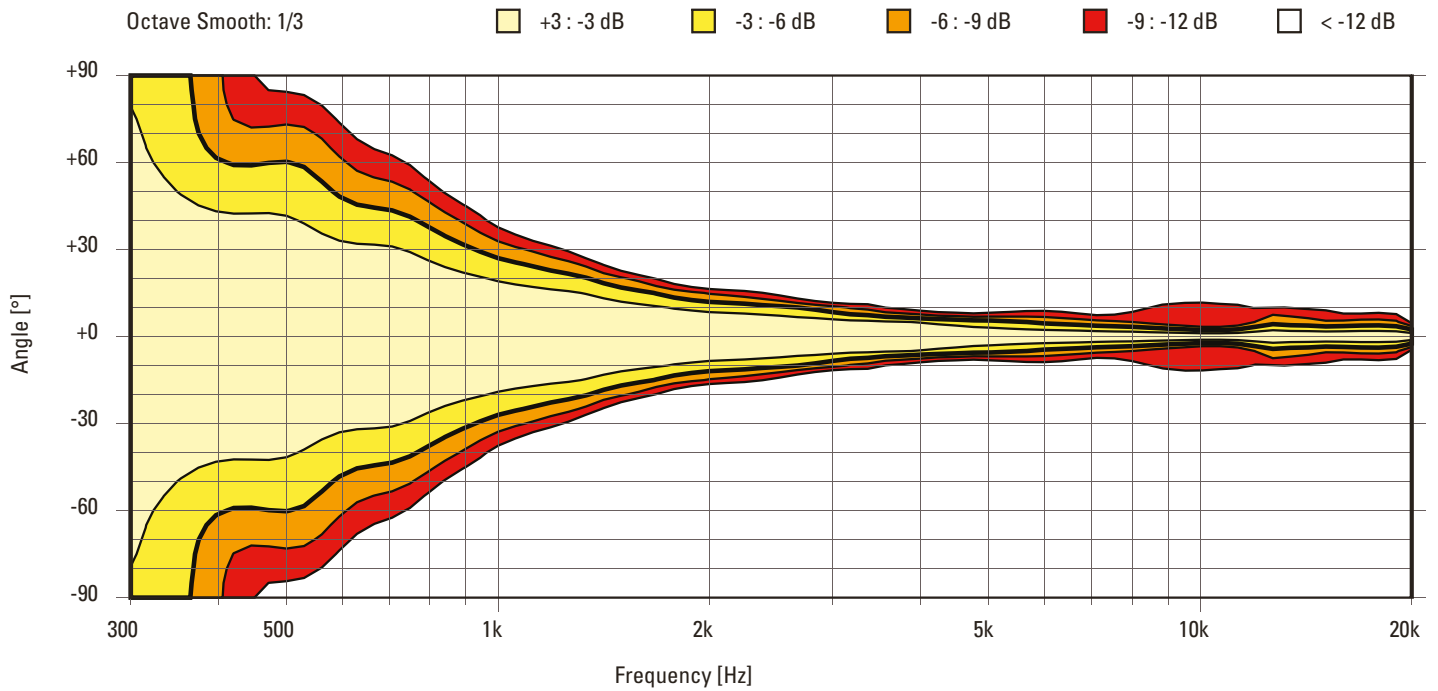

HIGH FREQUENCY HEADROOM

The high-frequency section of GTO covers a large part of the audio spectrum, operating between 1kHz and 18kHz. Since this frequency range includes most of those that contribute to intelligibility, especially at long ranges, it is absolutely vital that there is the maximum possible power and headroom available in this band.

The key design element here is that the combination of four transducers each on DPRWG devices provides generous reserves of power and headroom for the engineer and system tech.

The result of this surplus power is remarkable far-field

transparency, less distortion, greater resolution, finer acoustic detail and unmatched impact, especially within the vocal range.

The HF section in a single GTO cabinet will produce a maximum SPL of 147 dB with appropriate amplifier power and system control.

Using the principles of line source technology this maximum rises to 153 dB when four cabinets are combined - a reassuring figure to those responsible for delivering audio to audiences in large arenas. For full technical details please consult the spec sheet.

MF SECTION

A common criticism of line-array systems, especially when compared to large point-source rigs, is the relative lack of midrange 'punch'.

The design of Outline's distinctive front baffle, following our V-Power Concept design, originates in our research into the most effective way of delivering high-powered midrange frequencies from a compact cabinet.

This groundbreaking design is proven to deliver superior electro-acoustic



transduction coherence and consequently a much greater physical impact in the critical 200Hz - 1kHz range produced by our midrange components.

Both the midrange and high frequency bands exit the GTO cabinet through the same 90° horizontal dispersion waveguide.

Advanced Finite Impulse Response (FIR) linear-phase processing is employed to control the crossover function between MF and HF which consequently is perfectly smooth with zero audible artefacts.

DYNAMIC EXCURSION

The mid range section of GTO contains four 8-inch cone transducers, a design we created to provide serious low-mid extension where required.

Our design principles have been verified in numerous real-life situations, where engineers have been able to use the additional dynamic capabilities and extended frequency response of these units to reproduce sources such as drums and male voices with amazing depth and realism.

THERE IS NO LOSS OF THE NATURAL TIMBRE, NO UNWANTED COMPRESSION, JUST PLENTY OF CLEAN POWER.

The mid range section in a single GTO cabinet will produce a maximum SPL of 144 dB with appropriate amplifier power and system control.

Using the principles of line source technology this maximum rises to 152 dB when four cabinets are combined. For full technical details please consult the spec sheet.

The combined mid / high performance of GTO is a result of intelligent design and advanced DSP, which allows a large number of individual transducers to work harmoniously together as a single 'virtual' component - the ultimate expression of line-source principles.

LF SECTION

The low frequency section of GTO is a hybrid band-pass design that has been designed to produce articulation and dynamic response, in the 50Hz to 200Hz range, that is much greater than the size of the cabinet would suggest.



Two 15" cone transducers are mounted in each GTO cabinet. Like all the other components within GTO these drivers are designed and manufactured exclusively for us, and the LF drivers feature a layered-silicone, dual-spider design which combines a desirable long excursion performance with

low weight and durability. The design also incorporates demodulating rings, a double waterproof treatment and triple-roll surrounds to ensure maximum stability.

The architecture of the GTO cabinet also allows appropriate airflow to the LF drivers to provide essential cooling via an ingenious self-ventilating circuit. This prevents build up of thermal energy in the voice coils and magnets, which in turn allows less compression, greater electro-mechanical parameter stability, lower distortion and enhanced reliability.

The emission vents on a GTO cabinet are horizontally arranged in a 'L-M-H-M-L' (Low-Mid-High-Mid-Low) configuration which provides superior dispersion coherence and a symmetrical coverage right across the entire 50Hz - 18kHz frequency range produced by the system.

The physical design of the GTO cabinet is a result of almost 40 years designing and building loudspeakers plus a significant investment in R&D and extensive prototyping. Our engineers have produced a very high-powered concert loudspeaker design which is light and compact but also very sturdy, and entirely free of any internal standing waves and acoustic resonance.



PETER GABRIEL'S "NEW BLOOD TOUR" at Arena Verona - Italy







ANDREA BOCELLI UK TOUR - First Direct Arena - Leeds, UK





GTO C-12

Line Source for the 21st Century

Outline GTO is one of the most potent line-source systems ever produced, and everyone who works with it comments on its effortless power, clarity and definition even in the largest and most demanding applications. For many of our clients however, there are numerous applications for a system that produces very nearly the same output power but in a lighter and more compact format. That is the market demand that has driven the development of GTO C-12.

Following the GTO concept of harnessing the power of multiple transducers in a compact cabinet, the new GTO C-12 contains dual high-power 12" LF drivers, four 6.5" midrange units and two 3" throat compression drivers. The HF section is mounted on the same award-winning DPRWG waveguide found in its big brother, incorporated within the Outline V-Power Concept front baffle design, which combines huge output with absolute controllability.

The footprint of the new cabinet is exactly the same as all the other modules in the GTO range, allowing full mechanical compatibility with GTO, GTO-SUB, GTO-LOW and GTO-DF in terms of rigging, flying hardware and wheelboards. As a reference point for existing Outline GTO owners and users, the GTO C-12 cabinet is 21.6% smaller in the vertical plane than the GTO, whereas the overall cabinet weight is down by a massive 30% - a remarkable feat of design engineering.

Our use of a special aluminium alloy for the integral rigging hardware, originally developed by Outline for GTO, contributes to this major weight saving. This unique system also provides twelve different adjustment settings in the angle between connected GTO C-12 cabinets, adding further to the real-world flexibility and adaptability of the loudspeaker.

With its technology derived completely from the large format dual 15" GTO, the new GTO C-12 produces output power surpassed only by its 'big brother'. Incorporating our V-Power Concept and patented DPRWG Wave Guide, and using the most advanced transducer technology available, the GTO C-12 carries the familiar high-resolution signature sound synonymous with the Outline brand and family of world renowned line array products.

This concentration of power into a smaller and lighter enclosure has significant benefits in terms of transportation, storage, deployment, crew requirements and operational efficiency. GTO C-12 extends the Outline concept of ultimate system flexibility, not just because it is mechanically compatible with all the other GTO modules but also because systems of virtually any size and power can be designed using GTO C-12. From arenas to 500-seat theatres and everything in between, from maximum thunder rock 'n roll to spoken-word performance, the remarkable capabilities of this system offer genuine commercial advantages to owners and users.

But it gets even better...

Our design team are developing a new lightweight flybar for GTO C-12 that will make this product a real game-changer, because using it will allow up to twelve GTO C-12 cabinets to be flown from a single 1-tonne flying point whilst staying within standard Safe Working Load restrictions.

This is big news for the many production companies that work in venues which only provide a single rigging point per side and / or have low flying weight limitations, because they can now bring in an easy-to-handle, compact system that is quick to rig and de-rig, which requires only one motor per side and yet produces more than enough power to handle any event. A 12-cabinet per-side GTO C-12 main

L&R system with a suitable complement of subwoofers (and infills if necessary) will deliver the definitive combination of outright SPL, intelligibility and controlled coverage that makes it the perfect go-to system for thousands of medium-sized venues throughout the world.

Thanks to the common-voicing approach that defines all our touring product designs, the GTO C-12 can of course be freely deployed with GTO systems for side hangs or delays, or supplemented with other Outline products when used as a main system.

GTO C-12 is fully compatible with the Outline GTO-SUB, DBS and LAB21 subwoofers. We can also supply suitable DSP controller presets for any combination of GTO C-12 and Outline subwoofers.

GTO C-12

FREQUENCY RESPONSE	-10 dB ±3 dB	45 Hz ÷ 18 kHz 65 Hz ÷ 17 kHz	MAX SHORT-TERM SPL @ 1 m, free-field *	147.5 dB SPL
AVERAGE DISPERSION	Horizontal Vertical	90° Depending on array configuration	Loudspeakers and Loading	Low Mid High
IMPEDANCE	Low Mid High	2 x 8 ohm (min 2 x 6 ohm) 8 ohm (min 6.6 ohm) 16 ohm (min 16.6ohm)		2 x 12" NdFeB Hybrid band pass loaded woofers 4 x 6.5" NdFeB partially horn loaded mid woofers 2 x 3" diaphragm NdFeB compression driver loaded by 2 D.P.R.W.G.
Sens @ 1W, 1m (Single unit, full space)	Low Mid High	102 105 110	Weight - single unit	72.5 kg (160 lb)
POWER - WAES	Low Mid High	2 x 400 (2 x 1600 peak) 600 (2400 peak) 250 (1000 peak)	DIMENSION	Net With Pins inserted
			Height Width Depth	363 mm (14.3") 1126 mm (44.3") 655 mm (25.8") 363 mm (14.3") 1181 mm (46.5") 655 mm (25.8")

* calculated using +10 dB crest-factor signal

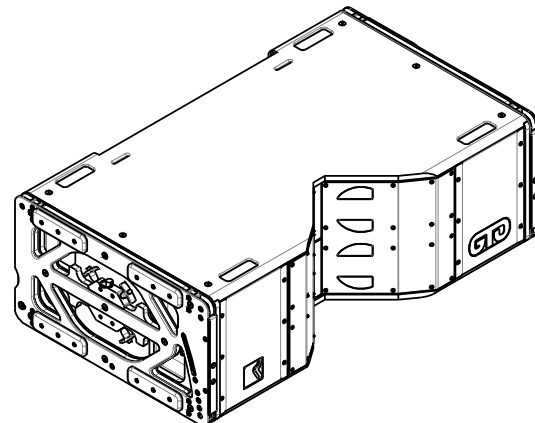
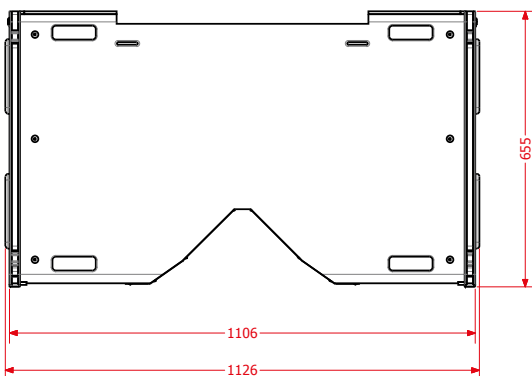
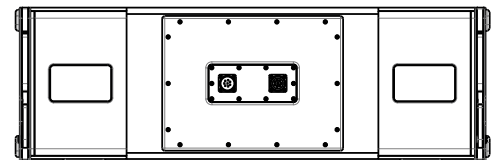
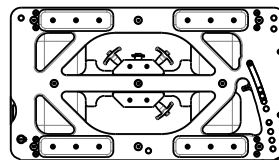
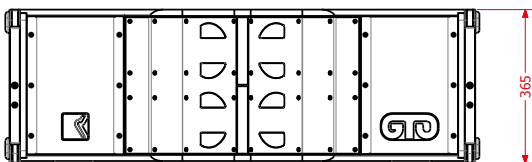



GTO-LOW BASS EXTENSION CABINET

The GTO-LOW is bass extension cabinet which features the same dual 15" drive units, physical dimensions and rigging hardware as the GTO cabinet. The reflex ports are also in the same configuration as GTO which preserves the low-frequency continuity of the array when cabinets are combined. This allows combinations of GTO, GTO C-12 and GTO-LOW to be deployed in a wide variety of ways depending on the application, venue and available space.

The GTO-LOW is designed to fulfil two main roles:

1. As a bass-extension cabinet for GTO or GTO C-12. GTO-LOW elements are normally driven via dedicated controller and amplifier channels, and a factory option is provided to extend low frequency response by selection of a user preset. In standard mode the frequency response of the GTO-LOW mirrors that of the low-frequency section of the GTO cabinet (50Hz to 200Hz), but the user may also choose to extend the range of the GTO-LOW cabinets down to 40Hz if the application requires it.

2. As a multi-purpose low frequency array element which can be used with other Outline systems including Mantas and Butterfly by selection of the correct user programs within the DSP controller. The frequency response of GTO-LOW is sufficiently flexible that it can be adjusted

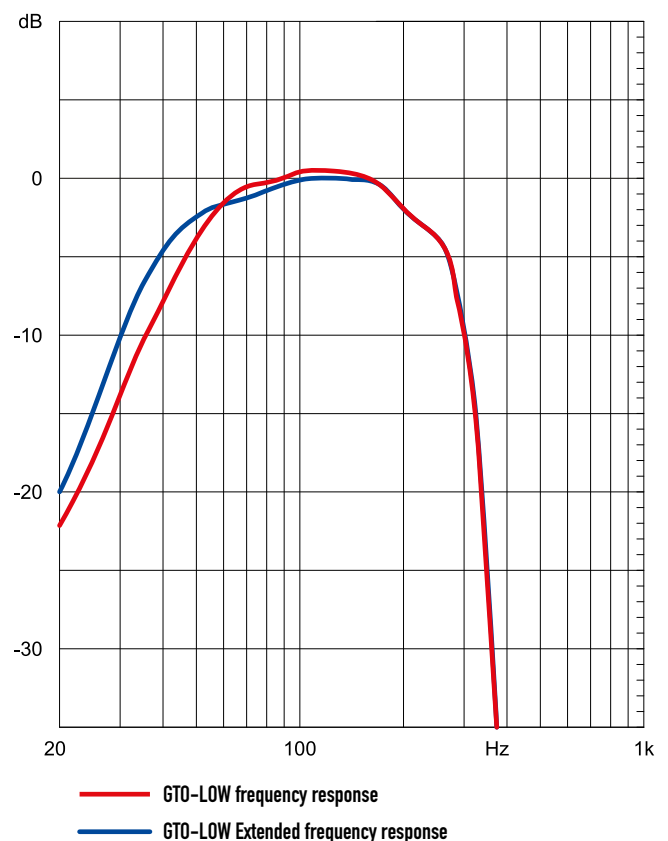

significantly through a range of values to suit various mid/high elements, and can easily handle up to 200Hz.

GTO-LOW modules have the same footprint and rigging hardware as the other GTO elements, so can be easily incorporated within any GTO array to extend its overall height. Depending on the exact configuration of cabinets, inclusion of GTO-LOW cabinets within a GTO or GTO C-12 array will extend the overall vertical height of the array, which, following the principles of line-source technology, will provide a downward extension of the low-frequency vertical pattern control, as well as adding extra low-frequency energy to the system as a whole.

GTO-LOW cabinets may also be configured to create a low-frequency cardioid coverage pattern, which can be extremely useful in many applications. Benefits include the removal of unwanted low frequencies on stage, much greater control over low frequencies in reverberant

spaces, and more precise overall system control in acoustically challenging venues.

All configurations of GTO/C-12/GTO-LOW arrays can be accurately modelled using Outline OPENARRAY simulation software, which will provide a visual representation of the overall system response, including changes in low frequency pattern control caused by varying the physical array height. Whilst the GTO-LOW has the same external shape as GTO to facilitate easy storage, transport and inclusion within GTO/C-12/GTO-LOW combination systems, there are some significant internal differences.

Because of its very high power handling and frequency response the whole structure features extensive internal bracing and a single-piece front baffle to maintain structural integrity. Despite all this extra internal engineering, GTO-LOW still weighs only 72 kg (159 lb) including the rigging hardware.





GTO-DF

The extremely narrow vertical dispersion characteristics required to make a line-source loudspeaker system function correctly, and the usual necessity to achieve minimum flown heights for the lowest part of the array, mean that many applications require additional loudspeaker elements to achieve satisfactory coverage of areas not covered by the main array.

The best and most consistent way to achieve this is by designing a dedicated cabinet that will normally provide the necessary 'downfill' output to cover the areas nearest the front of the stage.

Doing this correctly has significant benefits to both system technicians and mix engineers. Firstly it obviates the need for any additional floor space as the extra cabinet(s) should share the same rigging system as the main array and so simply attach to its lowest element when required. Secondly, the downfill cabinet should be voiced exactly the same as the main array and thus not require any additional equalisation to acoustically integrate correctly into the system.

The Outline GTO-DF meets and exceeds these essential design requirements. It features a high-efficiency mid-high element incorporating four 8" mid-range neodymium drive-units and two 3" diaphragm compression drivers on a proprietary acoustic lens, coupled to a special

asymmetric 'V-Power' baffle, as found in the GTO full range element, and which allows seamless acoustic integration of the midrange and HF elements into the main array. GTO-DF is designed to be bi-amped using dedicated amplifier channels and DSP control. To match the output power of GTO and GTO C-12 the GTO-DF features high power handling (3200 midrange / 1000 watts HF AES peak) and delivers massive sound pressure levels (max 144.5 dB SPL peak at 1 metre).

GTO-DF also features an identical footprint and rigging system to GTO and GTO C-12, allowing quick and easy integration into any design of system, and also uses the standard GTO wheelboard for safe storage and transportation.

As with all GTO elements, design files are available within the 'OpenArray' 3D acoustic simulation software.



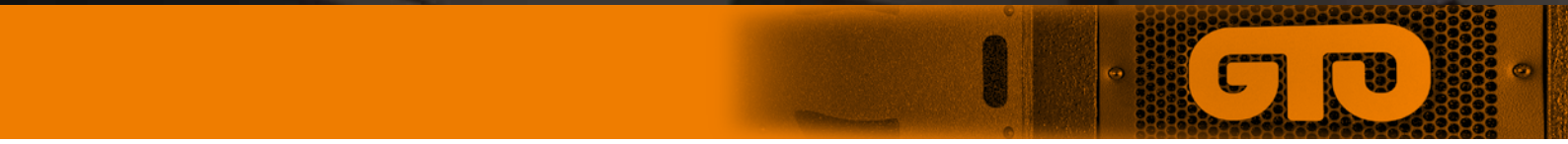
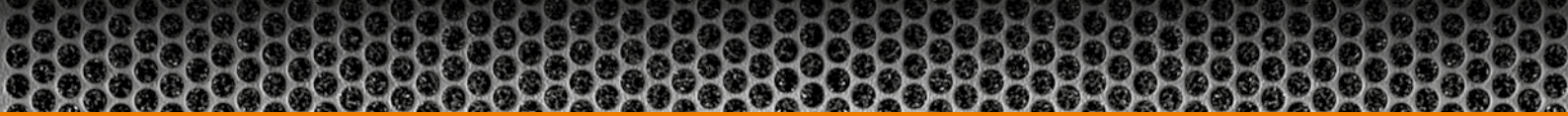



GTO-SUB

To fully realise the extraordinary potential of the GTO concept it is of course necessary to supplement the system with suitable low-frequency reinforcement. Creating a dedicated subwoofer that is capable of keeping up with GTO and GTO C-12 has been a challenge for our design engineers, and one to which they have responded with their usual imagination and technical innovation.

The GTO-SUB is a high-efficiency dedicated subwoofer featuring dual long-excursion 18" (457mm) transducers. The unique cabinet design provides class-leading electroacoustic performance, able to handle up to 9600W AES peak power and delivering extremely high continuous SPLs with very low power compression and distortion.

Integral to the GTO-SUB design is an example of Outline's innovation in loudspeaker design, namely the 'Decoupled Baffle Subwoofer' assembly. This ingenious concept contributes to the structural integrity of the entire cabinet as well as reducing resonance (and thus unwanted colouration) as well as air turbulence noise from the reflex ports.

The GTO-SUB is equipped with the same high-precision, low-weight rigging system as GTO, including the top flying frame, which allows up to sixteen subwoofer cabinets to be flown in a vertical orientation. Up to twelve GTO-SUB enclosures can be flown in a non-vertical array if the application

requires adjustment of splay angles using the integral rigging system. Suspended arrays may also incorporate forward and rearward facing cabinets to facilitate cardioid pattern control, and all configurations may be precisely simulated using Outline's proprietary 'OpenArray' 3D acoustic simulation software.

For electro-acoustic reasons it is not possible (or desirable) to integrate GTO, GTO C-12, GTO-LOW or GTO-DF into arrays of GTO-SUB.

GTO-SUB also uses the same standard wheelboards as the other GTO elements, allowing safe transportation and storage when stacked up to three units high on a single dolly.



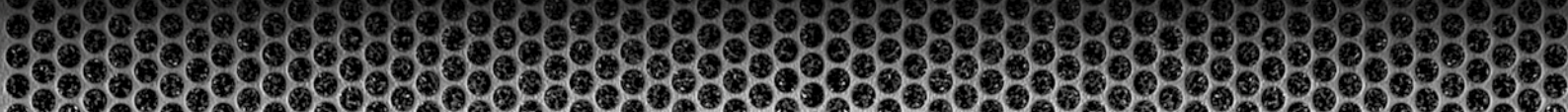

LIPF 082

The new Outline LIPF082 is a true multi-purpose problem solver. Voiced specifically to integrate freely with Outline loudspeaker systems and sharing components from our famous Mantas product, its frequency response and essential tonality is also flexible enough to be equalised to compliment products from other manufacturers.

LIPF082 is a two-way, bi-amp only design containing dual reflex-loaded 8" LF neodymium-magnet transducers and a single 2.5" exit titanium-diaphragm compression driver mounted on a 120° x 25° constant-directivity horn. The enclosure is constructed using quality void-free birch ply finished in a waterproof scratch-resistant black paint finish which provides effective protection against real-world use.

A compact and unobtrusive loudspeaker enclosure, the LIPF 082 is specifically designed to provide near-field reinforcement. Typical applications include stage-lip and under-balcony fills, though it also makes a very effective small monitor for musicians in situations where space is at a premium, such as crowded orchestra pits.

Its diminutive size belies its power, however, as this little



powerhouse is rated at 137dB SPL peak @ 1m. Measuring just 24.3cm (9.6") x 65.3cm (25.7") x 41cm (16.1") and weighing in at 23.2 kilograms (51.1 pounds), LIPF 082 is ideal for any requirement that demands power and fidelity in an enclosure that can be deployed discreetly and which will not compromise sight lines.

The relative impedance of the components allow up to eight LIPF 082s to be powered from just two stereo amplifiers, making it a cost-effective solution for many applications. Integrated M8 rigging hardware on five of its six sides provides multiple mounting and installation options.

This extremely useful and flexible Outline product adds a vital component to the 'audio toolbox' of sound designers, systems integrators and touring production companies.



LIPF 082

FREQUENCY RESPONSE	(-10 dB) (±3 dB)	60 Hz ÷ 20 kHz 80 Hz ÷ 18 kHz
AVERAGE DISPERSION	Horizontal Vertical	120° 25°
IMPEDANCE (Ω)	Low/Mid (min) High (min)	8 (6.6) 16 (11.9)
POWER HANDLING - WATT AES	Low/Mid High	Cont. 400 80 Peak 1600 320
MAX SHORT-TERM SPL @ 1 m, free-field *		137 dB SPL
CONNECTORS	Low/Mid High	2 x NL4 Speakon in parallel Pin 1+ pos; Pin 1- neg Pin 2+ pos; Pin 2- neg
LOUDSPEAKERS AND LOADING	Low/Mid High	2 x 8" NdFeB bass reflex, direct radiation woofers 1 x 2.5" diaphragm on high directivity wave guide
WEIGHT	<i>Single unit</i> 23.2 kg (51.1 lb)	<i>Shipping (2 units)</i> 52 kg (114.6 lb)
DIMENSIONS	Height Width Depth	243 mm (9.6") 654 mm (25.7") 410 mm (16.1") 590 mm (23.2") 710 mm (28") 540 mm (21.3")

* calculated using +10 dB crest-factor signal



OPENARRAY 3D SIMULATION SOFTWARE

OPENARRAY 3D is Outline's acoustic simulation software, providing full three-dimensional emulation programs that will accurately predict the acoustic response from a wide range of Outline products, including all our line-source products and subwoofers, as well Outline's most popular point source systems.

Created entirely in-house by the Outline R&D team, OPENARRAY 3D is a vital tool for both fixed and mobile applications and facilitates optimisation of various Outline loudspeaker systems.

It is also particularly useful for configuring, installing and aiming our Mantas, Butterfly and GTO line-source systems.

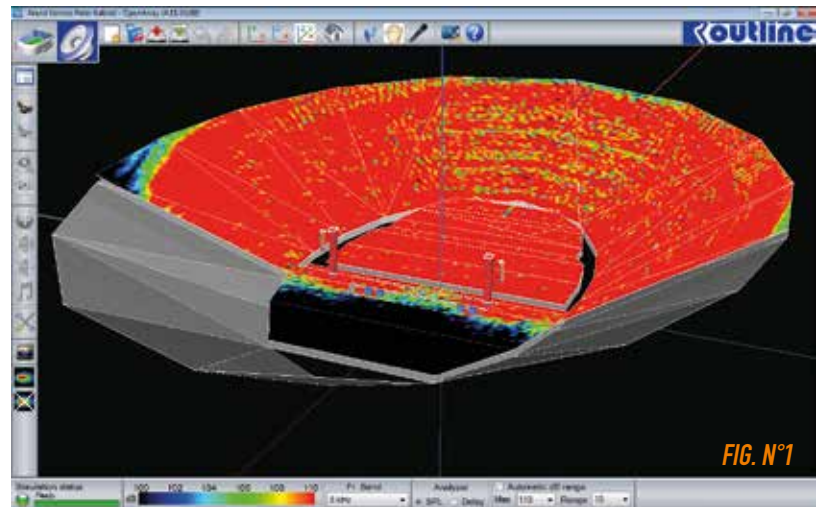

FIG. N°1

FIG. N° 1: MULTI-LEVEL OUTDOOR AMPHITHEATRE

Sound reinforcement design for a multi-level outdoor amphitheatre by means of the use of two GTO arrays (FOH system) and two Butterfly arrays (side-fill duties). Openarray 3D can import DXF files (the standard format for CAD-type files), even those regarding considerably complex venue layouts.

The software enables to view the predicted SPL (sound pressure level) for each individual frequency. It also allows to check the frequency response selected at any point in the listening zone.

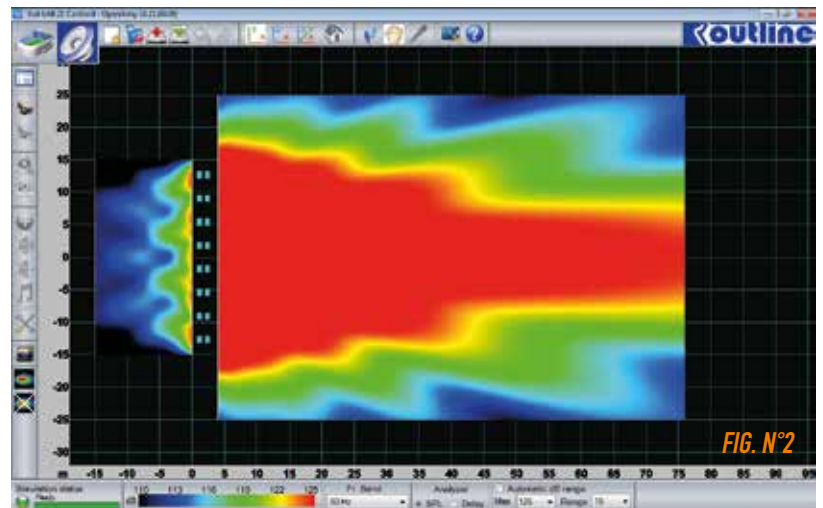

FIG. N°2

FIG. N° 2: SUBWOOFERS IN CARDIOID CONFIGURATION

Openarray 3D also ensures accurate simulations regarding "cardioid" configurations of enclosures used to reproduce low frequencies.

The example in the illustration shows the SPL produced by 16 subwoofers in the aforementioned configuration at a frequency of 50 Hz.

FIG. N° 3: MECHANICS, WEIGHTS, ANGLES

An accurate prediction of the angle between the elements - even if they are a combination of GTO, GTO-LOW, Butterfly and Mantas - greatly facilitates "aiming" at the audience. Riggers are thus provided with all the geometric and mechanical data necessary for carrying out their work perfectly, without worrying about committing any serious mistakes.

A diagram is created for each array, with all the parameters for flying according to limits set by international safety norms for suspended loads.

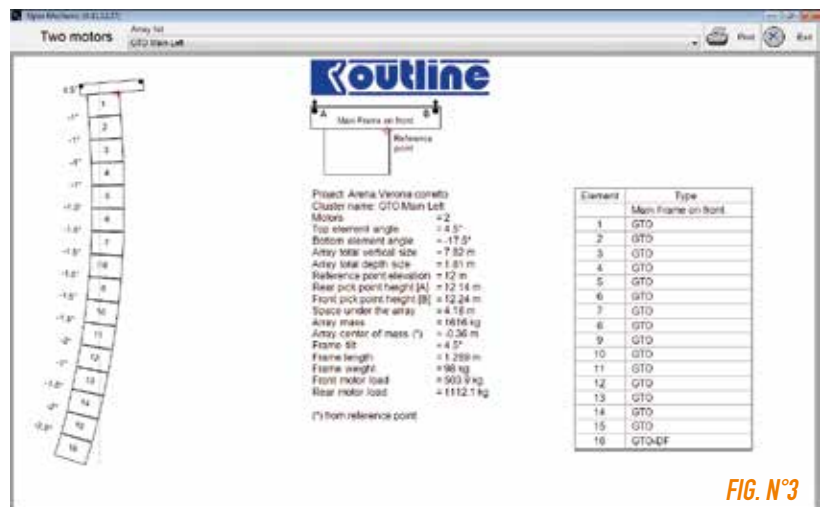

FIG. N°3

FREQUENCY RESPONSE (PROCESSED)	GTO	GTO-LOW	GTO-DF	GTO-SUB
(-10 dB)	35 Hz ÷ 18 kHz	33 Hz ÷ 300 Hz 27 Hz ÷ 300 Hz **	200 Hz ÷ 18.5 kHz	28 Hz ÷ 160 Hz
(±3 dB)	50 Hz ÷ 18 kHz	47 Hz ÷ 250 Hz 41 Hz ÷ 250 Hz **	250 Hz ÷ 17.8 kHz	34 Hz ÷ 107 Hz
AVERAGE DISPERSION				
Horizontal	90°	Quasi-omnidirectional	120°	Quasi-omnidirectional
Vertical	Depending on array configuration	Depending on array configuration	From +0° to -25° (on axis -12.5°)	Depending on array configuration
IMPEDANCE (Ω)				
LOW	2 x 8 Ω (min 6.5 Ω)	2 x 8 Ω (min 6.5 Ω)		2 x 8 Ω (min 6.2 Ω)
MID	8 Ω (min 6.8 Ω)		8 Ω (min 6.8 Ω)	
HIGH	16 Ω (min 15.3 Ω)		16 Ω (min 16.7 Ω)	
SENSITIVITY ref. 1W/1m* full space				
LOW	100	100		97
MID	105		105	
HIGH	110		101	

POWER HANDLING - WATT AES	GTO		GTO-LOW		GTO-DF		GTO-SUB	
	<i>Cont.</i>	<i>Peak</i>	<i>Cont.</i>	<i>Peak</i>	<i>Cont.</i>	<i>Peak</i>	<i>Cont.</i>	<i>Peak</i>
LOW	2 x 600 W	2 x 2400 W	2 x 600 W	2 x 2400 W			2 x 1200 W	2 x 4800 W
MID	800 W	3200 W			800 W	3200 W		
HIGH	500 W	2000 W			250 W	1000 W		

MAX SPL - dB @ 1 m* (calculated)	GTO	GTO-LOW	GTO-DF	GTO-SUB
MAX SHORT-TERM SPL @ 1 m, <i>Single Unit, free-field ***</i>	149.5 dB SPL	141 dB SPL	144.5 dB SPL	141 dB SPL
MAX SHORT-TERM SPL @ 1 m, 4 Boxes, free-field *** <i>Simulated at 20 m - referred at 1 m</i>	157.5 dB SPL	153 dB SPL		153 dB SPL

LOUDSPEAKERS AND LOADING	GTO	GTO-LOW	GTO-DF	GTO-SUB
LOW	2 x 15" hybrid band-pass loaded woofers	2 x 15" hybrid band-pass loaded woofers		2 x 18" hybrid band-pass loaded woofers
MID	4 x 8" NdFeB partially horn loaded mid-woofer		4 x 8" NdFeB partially horn loaded mid-woofer	
HIGH	4 x 3" diaphragm NdFeB compression driver loaded by 2 double V-coupled D.P.R.W.G.		2 x 3" diaphragm NdFeB compression driver loaded by an acoustic lens coupled to a constant directivity horn	
WEIGHT - Single Unit	96.0 kg (212 lb)	72.0 kg (159 lb)	78.0 kg (172.0 lb)	102.0 kg (225 lb)

DIMENSIONS	GTO		GTO-LOW		GTO-DF		GTO-SUB	
	<i>Net</i>	<i>With Pins inserted</i>	<i>Net</i>	<i>With Pins inserted</i>	<i>Net</i>	<i>With Pins inserted</i>	<i>Net</i>	<i>With Pins inserted</i>
WIDTH	1126 mm (44.3")	1181 mm (46.5")	1126 mm (44.3")	1181 mm (46.5")	1126 mm (44.3")	1181 mm (46.5")	1126 mm (44.3")	1181 mm (46.5")
HEIGHT	465 mm (18.31")	465 mm (18.31")	465 mm (18.31")	465 mm (18.31")	465 mm (18.31")	465 mm (18.31")	605 mm (23.82")	605 mm (23.82")
DEPTH	655 mm (25.8")	655 mm (25.8")	655 mm (25.8")	655 mm (25.8")	655 mm (25.8")	655 mm (25.8")	655 mm (25.8")	655 mm (25.8")

NOTES: * Referred to GTO HF throat || ** Extended mode
*** calculated using +10 dB crest-factor signal



GTO

GTO-LOW

FRONT VIEW

SIDE VIEW

FRONT VIEW

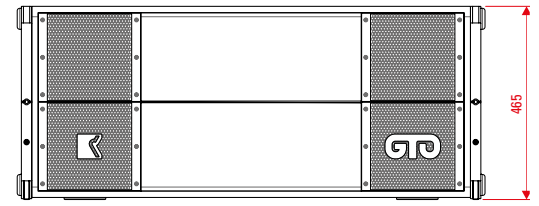
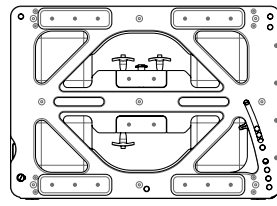
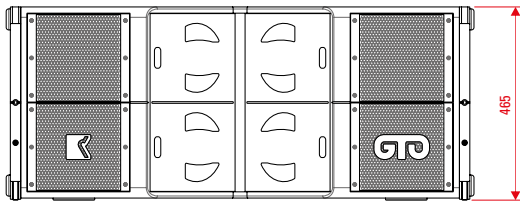

TOP VIEW

TOP VIEW

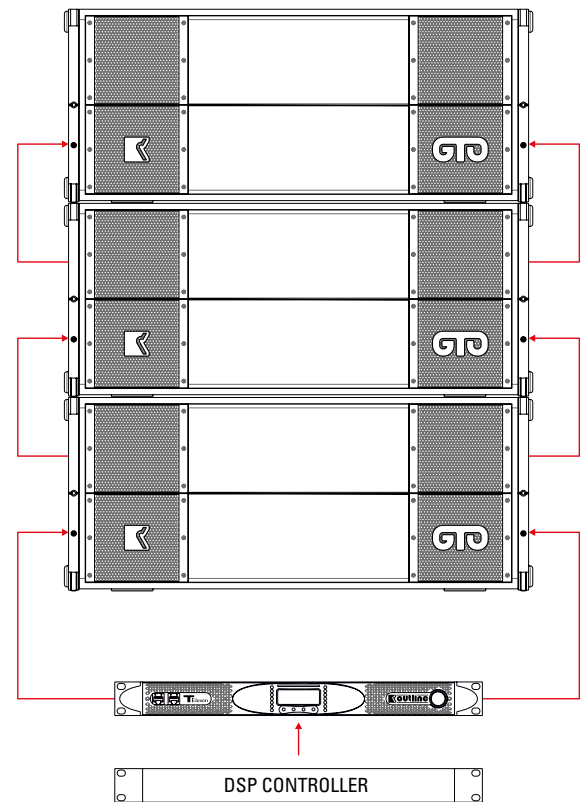
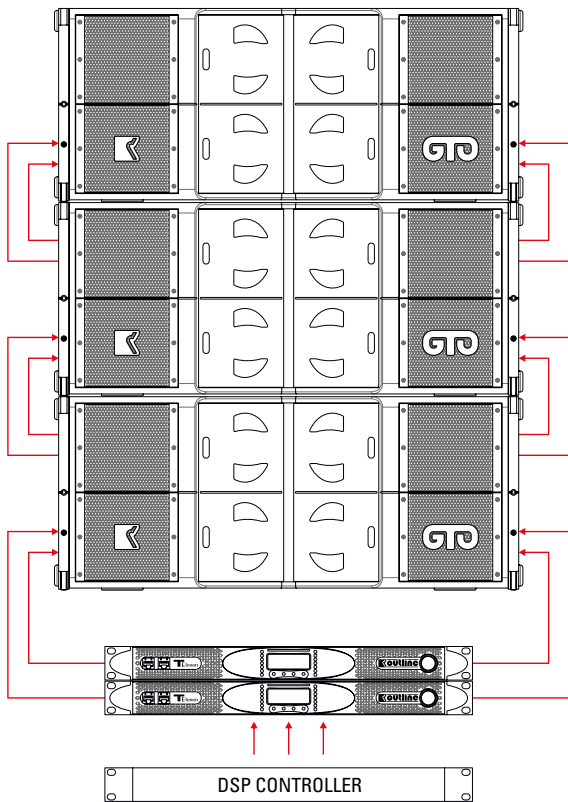
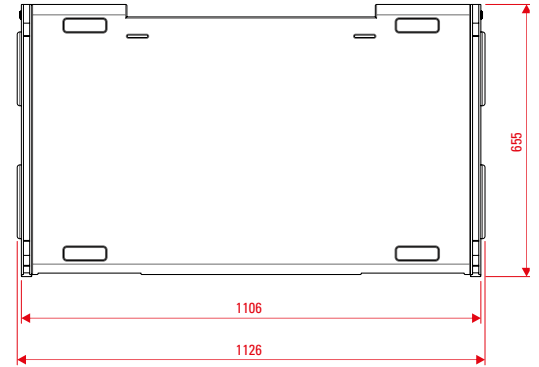
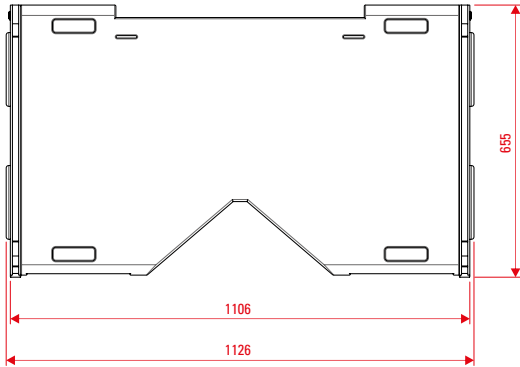

GTO-DF

FRONT VIEW

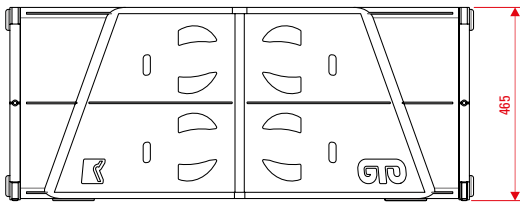

SIDE VIEW

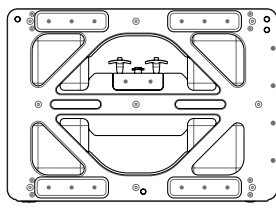

TOP VIEW

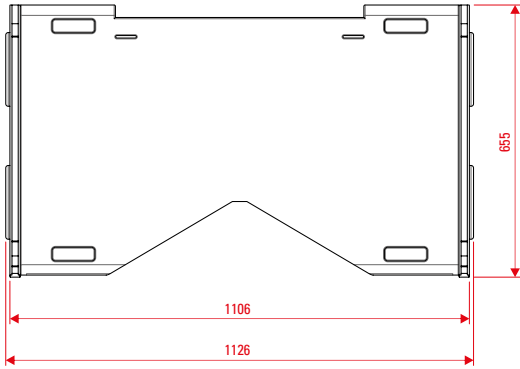

GTO-SUB

FRONT VIEW

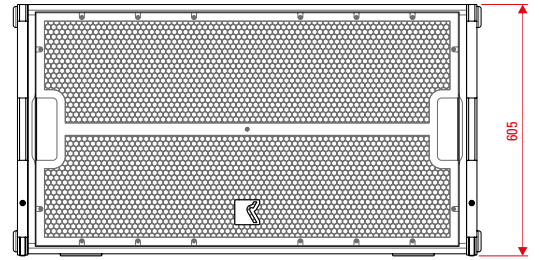

SIDE VIEW

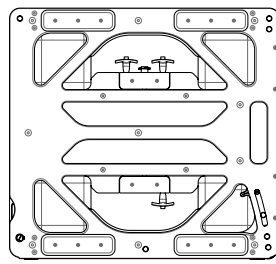

TOP VIEW

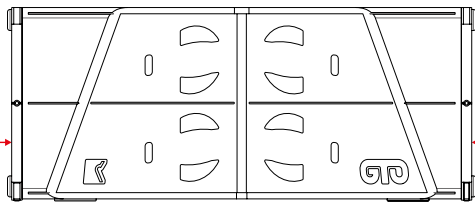
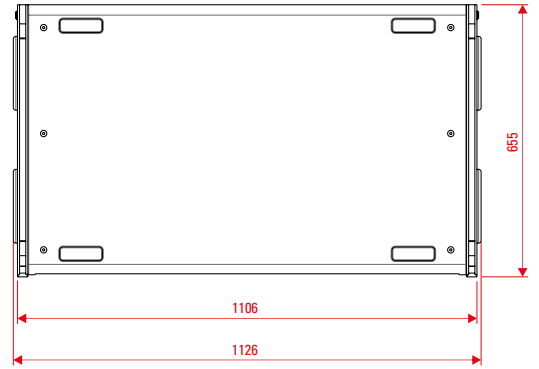

DSP CONTROLLER

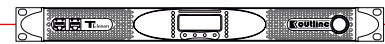
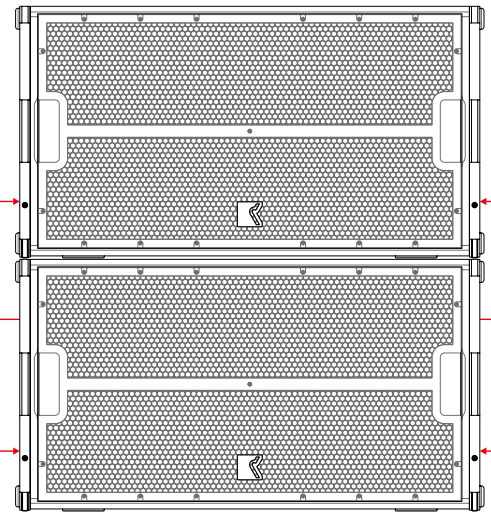

DSP CONTROLLER



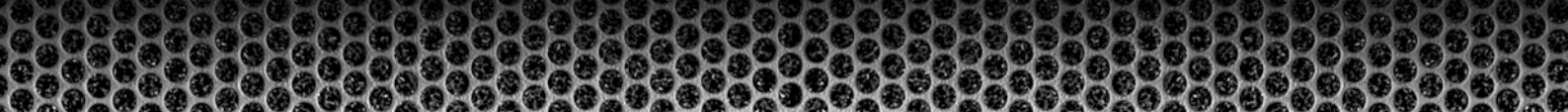

JOEL OSTEEN MINISTRIES AMERICA'S NIGHT OF HOPE - Yankee Stadium - NY, USA

A MESSAGE FROM OUR CEO



Dear audio professional

My name is Giorgio Biffi, and I am the CEO of Outline s.r.l. Thank you for reading this information on our new GTO system, I hope that it has given you a feel for what we are trying to achieve and that you will have the opportunity to hear the system in action soon.

The words and pictures you have seen accurately describe GTO, its components and performance, but to appreciate the whole picture you need to know a little more about us, our company, our philosophy and our motivation.

Outline was established in 1973 as a manufacturer of high-end hi-fi products. Our passion for audio reproduction of the highest possible standard was, and remains, a prime driving force for our R&D, manufacturing and management teams. We love to listen to great music reproduced as perfectly as possible, regardless of whether we are sitting at home with a glass of wine or standing in field with 50,000 other people. Great audio touches the soul in a way that almost nothing else does - that is our goal.

Of course, the differences between a good hi-fi and a good concert loudspeaker system go far beyond simply SPL. Primarily hi-fi has to deliver only to one or two people in a fixed and predictable environment whereas touring sound systems must be able to reach huge numbers of people in a wide variety of places. The concert-goer also pays handsomely for the ticket and so naturally expects to enjoy first-class sound reproduction regardless of where they are located in the venue.

In 2002 I heard the first Outline line-source system Butterfly and it was an unforgettable experience. We acquired the use of an airfield and set up listening positions at 40, 80 and 120 metres from the array to carry out objective listening tests. Over an extended period we moved all around the area, listening critically to every nuance of the music, which for test purposes was a selection of pre-recorded material.

The climax of the day for me came when I was standing 120 metres from the array as the engineer played a track featuring perhaps the greatest tenor of all time, the immortal Luciano Pavarotti. I immediately experienced goosebumps all over as the maestro's voice soared, and it seemed that he was really there, singing just for me, and from only a metre or two away.

GTO is the natural development of many of the technologies that were pioneered in that system, and allows listeners even in the largest venues to experience the same emotion, joy and excitement as I did that day at the airfield. Delivering that emotional experience is what drives us forward to keep researching and refining our products.

A key factor that allows us to deliver this experience is the coverage and long-throw capability of GTO, which eliminates the need for additional delay systems, whereas almost all other systems require supplementary reinforcement for areas over 50 metres from the stage. This is critical because it also removes the possibility of any time-alignment problems and thus phase incoherence between loudspeaker locations, which can only diminish the listening experience for parts of the audience. Obviously it also has a major positive impact on system deployment and transport costs for the sound provider.

I personally extend a warm invitation to all music lovers, sound engineers, production managers and audio professional everywhere to come and experience GTO for yourselves. I assure you that your perception of what is possible from large-format line-source systems will be permanently altered.

Sincerely yours
Giorgio Biffi

A handwritten signature in black ink that reads "Giorgio Biffi". The signature is written in a cursive, flowing style.

A large, stylized orange logo consisting of the letters "GTO" in a bold, rounded font. The logo is set against a background of a metallic surface with a circular perforated pattern, similar to a speaker grille.

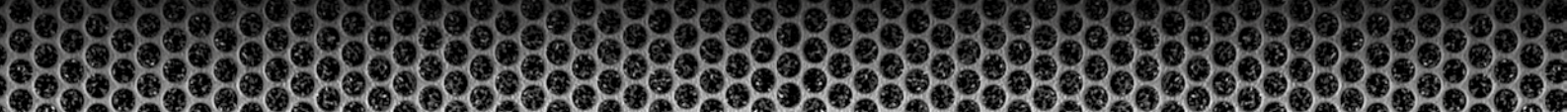

OUTLINE ITALY
Tel.: +39 030 35.81.341
Fax +39 030 35.80.431
mail to: info@outline.it
www.outline.it



OUTLINE NORTH AMERICA LLC
Tel.: 516 249 0013
Fax: +1 914 219 4181
Mob.: +1 917 873 3602
mail to: na_sales@outline.it